

Description of Operation

Electromechanical Power Bolts are designed for those applications where a positive latching action is needed. When extended, the bolt enters the strike with a positive engagement. Power bolts are available in several forms for a wide variety of uses.

Standard Features

Input Voltages - 12VDC or 24VDC field selectable.

Bolt Operation - *Fail Safe* - Bolt retracts when power is removed.

Fail Secure - Bolt extends when power is removed.

Options:

<u>RC1</u> -	A rectifier/filter (RC1) externally mounted to convert an AC voltage to DC voltage at the lock.
<u>ATS (Antitamper Switch)</u> -	Detects the unauthorized removal of the housing cover on surface mounted Power Bolts.
<u>BPS (Bolt Position Switch)</u> -	A switch which indicates the bolt is extended or retracted.
<u>DSM (Door Status, Magnetic)</u> -	Magnetic switch contacts which change state when the door is closed, actuated by a magnet located in the strike plate.
<u>DSB (Door Status, Ball)</u> -	A ball switch mounted on the Power Bolt face which is mechanically actuated by the closing of the door.
<u>ARSM (Automatic Relock Switch, Magnetic)</u> -	Switching contacts in the solenoid coil circuit which prevent the bolt from extending until the magnetic switch senses that the door is closed.
<u>ARSB (Automatic Relock Switch, Ball)</u> -	Same as the ARSM, except that door closure is detected by a ball switch.

575 Birch Street, Forestville, CT 06010
 (860) 584-9158 Fax (860) 584-2136

Figure 1 - 12V configuration without ARSM option

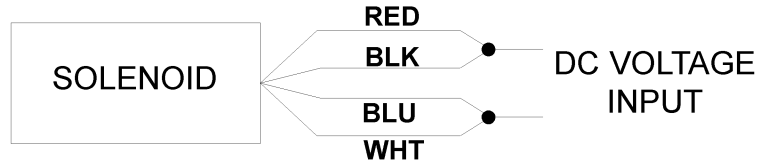

Figure 2 - 24V configuration without ARSM option

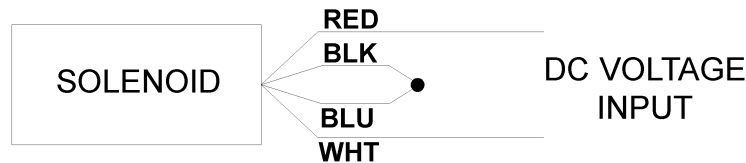
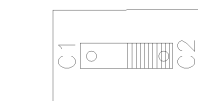
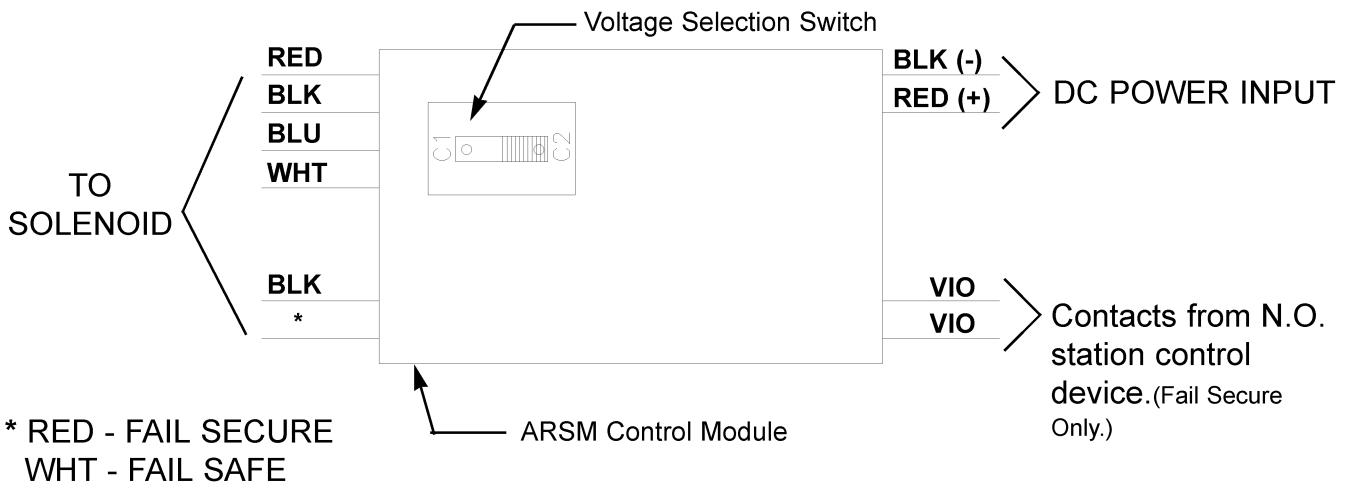

Figure 3 - 12V or 24V configuration with ARSM option



24VDC Position



12VDC Position

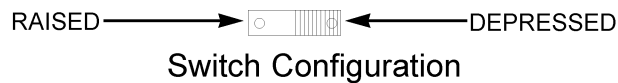

575 Birch Street, Forestville, CT 06010
 (860) 584-9158 Fax (860) 584-2136

Figure 4 - ATS (Antitamper Switch)

The ATS provides a signal to indicate removal of the housing cover. The ATS can be wired to an alarm, indicator or console to warn of unauthorized tampering with the lock. The ATS provides a signal via a set of Form "C" dry contacts.

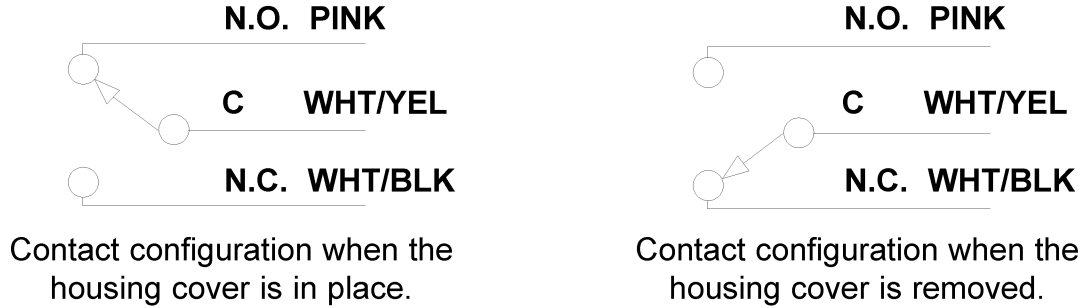

Figure 5 - DSM, DSB (Door Status Switch)

The DSM, and DSB provides a signal to indicate whether the door is open or closed. The lock mounting instructions should be followed closely to ensure reliable performance of this option. The DSM, and DSB provides a signal via a set of Form "C" dry contacts.

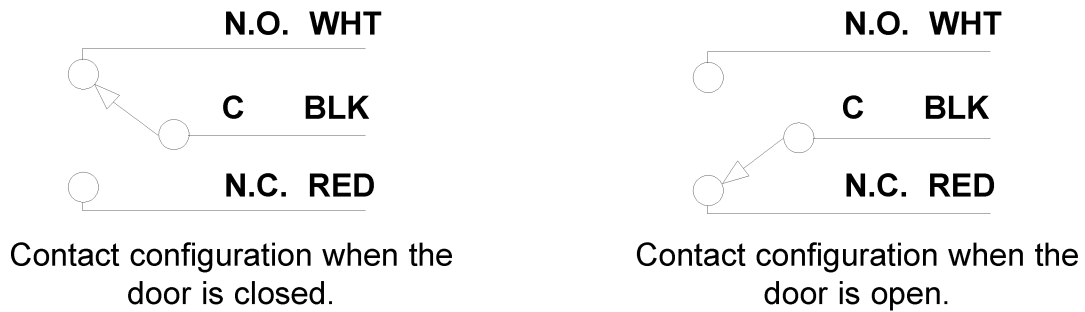
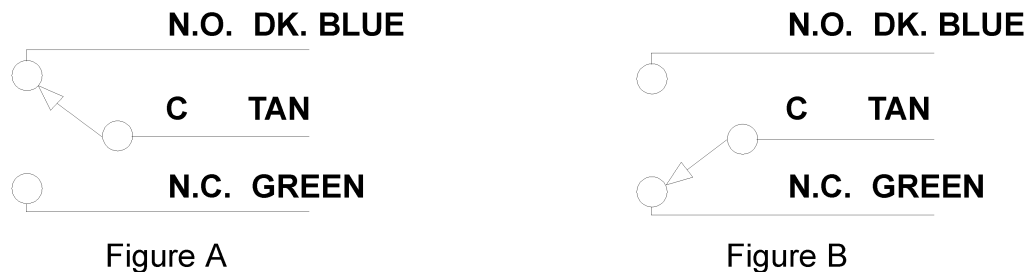

Figure 6 - BPS (Bolt Position Switch)

The BPS senses whether the bolt is projected or retracted. The BPS provides a signal via a set of Form "C" dry contacts.



BOLT FUNCTION	MODEL	BPS INDICATED	NOT ENERGIZED	ENERGIZED
FAIL SECURE	405S & 406S ALL OTHERS	BOLT RETRACTED BOLT PROJECTED	FIGURE A FIGURE B	FIGURE B FIGURE A
FAIL SAFE	405 ALL OTHERS	BOLT PROJECTED BOLT RETRACTED	FIGURE A FIGURE B	FIGURE B FIGURE A

575 Birch Street, Forestville, CT 06010
 (860) 584-9158 Fax (860) 584-2136

Figure 7 - RC1 (Rectifier Capacitor Option)

The RC1 converts 12 or 24 volts AC to 12 or 24 Volts DC. The RC1 has four wires. The two yellow wires are the AC Voltage Input. The Red wire is the positive DC output. The White wire is the negative DC output.

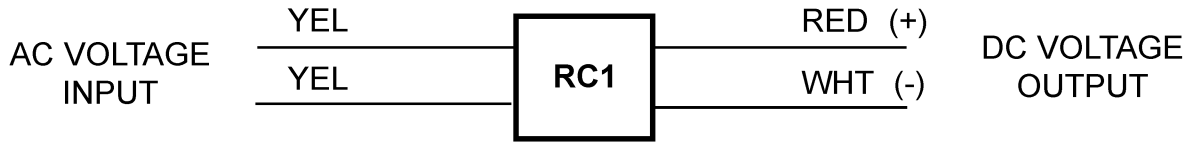

Figure 8 - Typical Release Switch Wiring

