

System Introduction

S E C T I O N 1

1.1 Specifications

Control Panel Specifications

Flexible Zone Configuration:

- 8 fully programmable zones
- 37 access codes: 32 user, 1 System Master, 2 Partition Master and 2 Duress
- Expandable to 32 zones
- Hardwired expansion available using the PC5108 Eight Zone Expansion Module
- Normally closed, single EOL or double EOL zone supervision
- 22 zone types, 7 programmable zone options
- 2 partitions

Audible Alarm Output:

- Supervised bell output (current limited at 3 amps), 12 Vdc
- Steady or pulsed output

EEPROM Memory: will not lose programming or system status on complete AC and battery failure

Programmable Outputs:

- Up to 14 programmable voltage outputs, 14 programmable options
- One high current (300 mA) PGM output on main panel
- One low current (50 mA) PGM output on main panel
- Eight additional low current (50 mA) PGM outputs available using the PC5208 module
- Four high current (1 Amp) PGM outputs available using the PC5204 module
- One PC5204 output fully supervised for siren output

Powerful 1 Amp Regulated Power Supply:

- 550 mA auxiliary supply, 12 Vdc
- Positive Temperature Coefficient (PTC) components replace fuses
- Supervision for loss of AC power, low battery
- Internal clock locked to AC power frequency

Power Requirements:

- Transformer = 16.5 VAC, 40VA
- Battery = 12 volt 4 Ah minimum rechargeable sealed lead acid

Remote Keypad Specifications:

- 4 different keypads available:
 - PC5508 8 Zone LED Keypad
 - PC5516 16 Zone LED Keypad
 - PC5532 32 Zone LED Keypad
 - LCD5500 Alphanumeric Keypad
- Each keypad has 5 fully programmable function keys
- Connect up to 8 keypads
- Four wire (Quad) connection to Keybus
- Built in piezoelectric buzzer

Digital Communicator Specifications:

- Supports all major formats including SIA, Contact ID and 200 baud FSK
- Event initiated personal paging
- 3 programmable phone numbers
- 2 account numbers
- DTMF and pulse dialling
- DPDT line seizure
- Anti-jam feature
- Split reporting of selected transmissions to each telephone number

System Supervision Features

The PC5016 continuously monitors a number of possible trouble conditions including:

- AC Power Failure
- Telephone Line Trouble
- Loss of Internal Clock
- Failure to Communicate
- Trouble by Zone
- Low Battery Condition
- AUX Power Supply Fault
- Module Fault (Supervisory or Tamper)
- Fire Trouble
- Bell Output Trouble
- Tamper by Zone

False Alarm Prevention Features

- Audible Exit Delay
- Audible Exit Fault
- Urgency on Entry Delay
- Quick Exit
- Swinger Shutdown
- Recent Closing Transmission
- Communication Delay

Additional Features

- Auto Arm by Partition at Specified Time
- Keypad Activated Alarm Output and Communicator Test
- Keypad Lockout
- Audio Capability using the PC5928 Audio Interface Module which allows local intercom and Central Station 2-Way Listen in.
- All modules connect to the system via a four wire Keybus up to 1000'/330m from main panel
- Event Buffer can be printed using PC5400 RS232 Serial Interface module
- Supports the ESCORT 5580 Voice Prompt Module with Automation/Lighting Control
- 256 Event Buffer, Time and Date Stamped
- Upload/Download Capability

1.2 Additional Devices

1.2.1 Keypads

A maximum of eight (8) keypads can be connected to the control panel and can be any combination of the following listed. Different keypads (with function keys) can be used for different size systems; 8 zone, 16 zone and 32 zone.

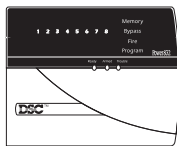

PC5508
8 zone LED keypad

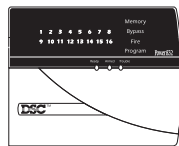

PC5516
16 zone LED keypad

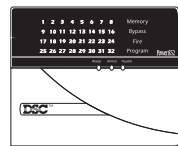

PC5532
32 zone LED keypad

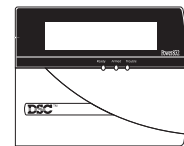

LCD5500
LCD keypad

1.2.2 PC5108 Eight Zone Expander Module

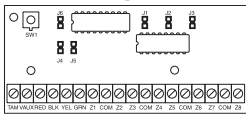

Eight zone expander module can be used to increase the number of zones on the system. Up to 3 modules can be connected to increase the system zones to a maximum of 32.

1.2.3 PC5204 Power Supply Output Module

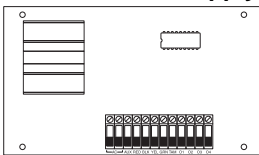

The PC5204 can provide up to 1 Amp of additional power for modules or devices connected to the control panel. The module requires a 16.5 volt AC 40 VA transformer and 4 AH battery. In addition, the module provides 4 programmable high current voltage outputs. Each output is individually programmable with 14 different output options available (See Section 5.10 "PGM Outputs").

1.2.4 PC5208 Eight Low Current Output Module

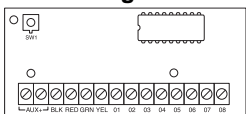

Adds eight low current outputs (50 mA) to the control. Each output is individually programmable with 14 different output options available (See Section 5.10 "PGM Outputs").

1.2.5 Escort5580 Module

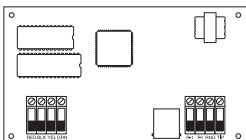

This Escort5580 module will turn any touch tone phone into a fully functional keypad. The module also includes a built-in interface to control up to 32 line carrier type devices for lighting and temperature control (See Section 5.26 "Escort5580 Module").

1.2.6 PC5928 Audio Interface Module

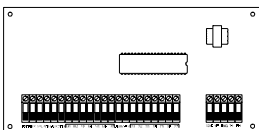

The PC5928 Audio Interface module is a simple way to incorporate paging, intercom, baby listen-in and door answer to the PC5016 control panel. The module also has built-in two-way voice capability for central station (See Section 5.28 "Audio Interface Module").

Three additional devices are available:



PC5921 PC5921EXT PC5921EXT/R

PC5921 Intercom Audio Station

The PC5921 Intercom Audio Station can be used in conjunction with the PC5928 Audio Interface Module.

PC5921 EXT Door Box Audio Station

The PC5921 EXT Door Box Audio Station can be used in conjunction with the PC5928 Audio Interface Module.

PC5921 EXT/R Door Box Audio Station

The PC5921 EXT/R Door Box Audio Station can be used in conjunction with the PC5928 Audio Interface Module. The Door Box contains a relay so the normal door bell can be used instead of the internal one generated by the PC5928 module.

1.2.7 PC5400 Printer Module

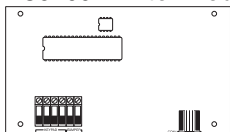

This PC5400 Printer Module will allow the panel to print out all events that occur on the system to any serial printer. All events will be printed with the Partition, time, date and the event that occurred (*See Section 5.27 "On-site Printer"*).

1.2.8 Cabinets

Several different cabinets are available for the PC5016 modules. They are as follows:

PC5003C Main control cabinet for the PC5016 main panel. Dimensions 288mm x 298mm x 78mm / 11.3" x 11.7" x 3" approximately.

PC5002C Cabinet to house the PC5204 Power Supply Output Module. Dimensions 213mm x 235mm x 78mm / 8.4" x 9.25" x 3" approximately.

PC5004C Cabinet to house the Escort5580 Module and PC5400 Printer Module. Dimensions 229mm x 178mm x 65mm / 9" x 7" x 2.6" approximately.

PC5001C Cabinet to house the PC5108 Zone Expander Module and the PC5208 Eight Low Current Output Module. Dimensions 153mm x 122mm x 38mm / 6" x 4.8" x 1.5" approximately.

PC5001CP Plastic cabinet to house the PC5108 Zone Expander Module and the PC5208 Eight Low Current Output Module. Dimensions 146mm x 105mm x 25.5mm / 5.75" x 4.2" x 1" approximately.

1.2.9 Backplates

There are two different backplates available for keypads to locate an Audio Station next to the keypad:

PC55BP1

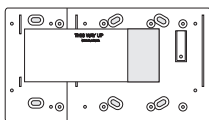

This backplate is to be used when an Audio Station is to be located next to a keypad. Dimensions 208mm x 115mm x 18mm / 8.2" x 4.5" x 0.25" approximately.

PC55BP2

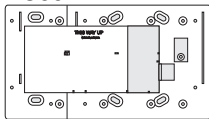

This backplate is to be used when an Audio Station is to be located next to a keypad. In addition the backplate will allow you to mount a PC5108 Zone Expander Module or the PC5208 Eight Low Current Output Module. Dimensions 208mm x 115mm x 18mm / 8.2" x 4.5" x 0.7" approximately.

1.3 Out of the Box

You should find the following equipment included in your system. Verify each of the components is included:

- one PC5016 main control cabinet
- one PC5016 main control circuit board
- one PC55XX (8, 16 or 32 zone LED)/LCD5500 keypad
- one hardware pack consisting of:
 - five plastic circuit board standoffs
 - sixteen 5600 ohm (5.6K) resistors
 - one 1000 ohm (1K) resistor
- one Installation Manual
- one Programming Worksheet Manual
- one Instruction Manual

Getting Started

S E C T I O N 2

The following sections provide a complete description of how to wire and configure devices and zones.

2.1 Installation Steps

The following steps are provided to assist with the installation of the panel. It is suggested that you read over this section briefly to get an overall understanding of the order of installation. Once this is done carefully work through each step. Working from this plan will help reduce problems and reduce the overall installation time required.

Step 1 Create a Layout

Draw a rough sketch of the building and include all alarm detection devices, zone expanders, keypads and all other modules that are required.

Step 2 Mounting the Panel

Locate the panel in a dry area, preferably located near an unswitched AC power source and the incoming telephone line. Before attaching the cabinet to the wall be sure to press the five circuit board mounting studs into the cabinet from the back. Mark the mounting holes on the wall. Drill the appropriate hole size and insert wall plugs into the holes. Next, using #8x1" round headed screws (or equivalent) secure the cabinet to the wall.



Complete all wiring before applying AC or connecting the battery.

Note: All holes in metal which have insulated wires passing through them should have bushings to prevent insulation breakdown.

Step 3 Wiring the Keybus (Section 2.3)

Wire the Keybus to each of the modules following the guidelines provided.

Step 4 Assigning Zones to Zone Expanders (Section 2.5)

If zone expander modules are being used the modules must be configured so the panel knows which zones are assigned to each expander. Follow the guideline provided to assign zones to expanders.

Step 5 Zone Wiring (Section 2.9)

Power down the control panel and complete all zone wiring. Follow the guidelines provided in Section 2.9 to connect zones using normally closed loops, single EOL resistor, double EOL resistors, fire zones and keyswitch arming zones.

Step 6 Completing Wiring

Complete all other wiring including bells or sirens, phone line connections, ground connections or any other wiring necessary. Follow the guidelines provided in Section 2.2 "Terminal Descriptions".

Step 7 Power up the Control

Once all zone wiring and Keybus wiring is complete, power up the control panel.



The panel will not power up if only the battery is connected.

Step 8 Keypad Assignment (Section 2.6)

Keypads must be assigned to different slots to be properly supervised. Follow the guideline provided in Section 2.6 to assign keypads.

Step 9 Enabling Supervision (Section 2.7)

After all modules have been wired to the Keybus, supervision must be enabled. Once supervision is enabled, the panel will be able to indicate module communication faults. Follow the guidelines provided in Section 2.7.

Step 10 Programming the System (Sections 4 and 5)

Section 4.0 provides a complete description of how to program the panel. Section 5.0 contains complete descriptions of the various programmable features, what options are available and how the options function. The Programming Work Sheets should be filled out completely before attempting to program the system.

Step 11 Testing the System

Test the panel completely to ensure that all features and functions are operating as programmed.

2.2 Terminal Descriptions

AC Terminals - AC



If the neutral in the main supply is not readily identifiable, then an appropriate disconnect device that has a contact separation of at least 3mm and disconnects both poles simultaneously, must be used.

Note: In order to comply with safety requirement IEC950, ensure that when the mains cabling enters the alarm panel, it is securely clamped to prevent it from being removed.

The panel requires a 16.5 volt, 40 VA transformer. Connect the transformer to an unswitched AC source and connect the transformer to these terminals.

! Do not connect the transformer until all other wiring is complete.

Interconnection circuits should be such that the equipment continues to comply with the requirements of IEC950 when like circuits are connected to each other. For example, TNV (telephone network) circuit should be connected to the TNV circuit, SELV (zoned) circuits should be connected to SELV.

Battery Connection

The battery is used to provide back up power in the event of an AC power failure and to provide additional current when the panel demands exceed the power output of the transformer, such as when the panel is in alarm.

! Do not connect the battery until all other wiring is complete.

Connect the RED battery lead to the positive of the battery, the BLACK battery lead to the negative.

Auxiliary Power Terminals - AUX+ and GND

These terminals provide up to 500 mA of additional current at 12 V_{DC} for devices requiring power. Connect the positive side of any device requiring power to the AUX+ terminal, the negative side to GND. The AUX output is protected; if too much current is drawn from these terminals (wiring short) the panel will temporarily shut off the output, until the problem is corrected.

Bell Output Terminals - BELL+ and BELL-

These terminals provide up to 3 Amps of current at 12 V_{DC} (with stand-by battery; 700 mA continuous) for powering bells, sirens, strobes or other warning type equipment. Connect the positive side of any alarm warning device to BELL+, the negative side to BELL-. The BELL output is protected; if too much current is drawn from these terminals (wiring short) the BELL fuse will open.

The Bell output is supervised. If no alarm warning device is being used connect a 1000 ohm resistor across BELL+ and BELL- to prevent the panel from displaying a trouble condition (See Section 3.4 "[*] Commands, [*][2]").

Keybus Terminals - RED, BLK, YEL, GRN

The Keybus is used by the panel to communicate with modules and by modules to communicate with the panel. Each module has four Keybus terminals that must be connected to the four Keybus terminals on the panel. For more information, see Section 2.3 "Keybus Operation and Wiring".

Programmable Outputs - PGM1 and PGM2

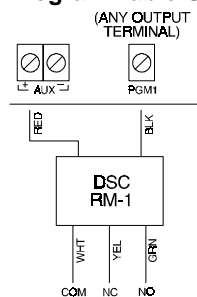

Each PGM output is an open collector switch to ground. That is, when the PGM output is activated by the panel the terminal will switch to ground. PGM1 can sink up to 50 mA of current to activate LEDs or a small buzzer. Connect the positive side of the LED or buzzer to AUX+, the negative side to PGM1. If more than 50 mA of current is required a relay must be used. Refer to the diagram, PGM2 is high current PGM (300mA) which operates similar to PGM1.

Zone Input Terminals - Z1 to Z8

Each detection device must be connected to a zone on the control. It is suggested that each zone have one detection device however it is possible to wire multiple detection devices to the same zone.

For zone wiring specifics, see Section 2.9 "Zone Wiring".

Telephone Connection Terminals - TIP, RING, T-1, R-1

If a telephone line is required for central station communication or downloading connect an RJ-31X jack in the following manner:

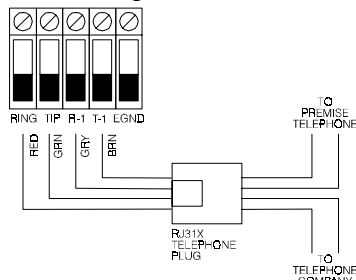

- RING - Red Wire _____ Incoming line from telephone company
- TIP - Green Wire _____ Incoming line from telephone company

- R-1 - Grey Wire _____ Outgoing line to house telephone(s)
- T-1 - Brown Wire _____ Outgoing line to house telephone(s)

! *Ensure the plugs and jacks meet the dimension, tolerance and metallic plating requirements of 47 C.F.R. Part 68, SubPart F. For proper operation there must be no other telephone equipment connected between the control panel and the telephone company facilities. Do not connect the alarm panel communicator to telephone lines intended for use with a FAX machine. These lines may incorporate a voice filter which disconnects the line if anything other than FAX signals are detected, resulting in incomplete transmissions.*

2.3 Keybus Operation and Wiring

The Keybus is used by the panel to communicate with all modules connected and by the modules to talk to the panel. The RED and BLK terminals are used to provide power while YEL and GRN are clock and data.

! *The 4 Keybus terminals of the panel must be connected to the 4 Keybus terminals or wires of all modules.*

The following conditions apply:

- Keybus should be run in minimum 22 gauge quad (0.5mm), two pair twist preferred
- the modules can be home run to the panel, connected in series or can be T-tapped
- any module can be connected anywhere along the Keybus, you do not need a separate Keybus wire run for keypads, zone expanders etc.
- no module can be more than 1,000'/330m (in wire length) from the panel
- shielded wire is not necessary unless wires are run in an area that may present excessive RF noise or interference

Example of Keybus Wiring

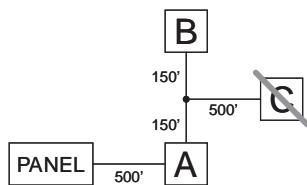

NOTE: Module (A) is wired correctly as it is within 1,000'/330m of the panel, in wire distance.

Module (B) is wired correctly as it is within 1,000'/330m of the panel, in wire distance

Module (C) is NOT wired correctly as it is further than 1,000'/330m from the panel, in wire distance.

2.4 Current Ratings - Modules and Accessories

In order for the Power832 system to operate properly, the power output capabilities of the main control and expansion devices must not be exceeded. Use the data presented below to ensure that no part of the system is overloaded and cannot function properly.

System Outputs (all 12 Vdc)

- PC5016
 - VAUX: 500 mA. Includes one keypad. Subtract for each additional keypad, expansion module and accessory connected to VAUX or Keybus.
 - BELL: 700 mA. Continuous Rating.
 - 3.0 A. Short Term. Available only with stand-by battery connected.
- PC5204
 - VAUX: 1.0 A. Continuous Rating. Subtract for each device connected.
 - 3.0 A. Short Term. Available only with stand-by battery connected.
- PC5208
 - VAUX: 250 mA. Subtract for each device connected. Subtract the total load on this terminal from the PC5016 VAUX/Keybus output.
- PC5108
 - VAUX: 100 mA. Subtract for each device connected. Subtract the total load on this terminal from the PC5016 VAUX/Keybus output.

Power832 Device Ratings (@ 12 Vdc)

- LCD5500 Keypad: 50 mA
- PC5532 Keypad: 45 mA
- PC5516 Keypad: 45 mA
- PC5508 Keypad: 45 mA
- PC5108 Zone Module: 35 mA
- PC5208 Output Module: 50 mA
- PC5204 Output Module: 20 mA
- PC5400 Printer Module: 62 mA
- Escort5580 Module: 150 mA
- PC5928 Audio Interface Module: 65 mA
- PC5921 Intercom Audio Station: 20 mA
- PC5921 EXT Doorbox Audio Station: 20 mA
- PC5921 EXT/R Doorbox Audio Station: 35 mA

Other Devices

Read the manufacturer's literature carefully to determine the maximum current requirement (during activation or alarm) and use this value for loading calculations. Do not allow connected devices to exceed the system capabilities during any possible operational mode.

2.5 Assigning Zones to Zone Expanders

The main panel contains zones 1 to 8. Additional zone expanders may be added to increase the number of zones on the system. Each zone expander consists of two groups of 4 zones and each group must be configured to assign the specific zones to the expander. This is done by setting the jumpers located on the expander to the proper settings.

! *Before a zone expander will work properly the jumpers must be set so the panel can determine the correct zone assignment.*

The following are the jumper settings for different zone assignments:

Expander Zones	Jumpers			System Zones Assigned
Group A (Zones 1-4)	J1	J2	J3	
Group B (Zones 5-8)	J4	J5	J6	
	ON	ON	ON	Zones not enabled for hardware operation
	OFF	ON	ON	Zones not enabled for hardware operation
	ON	OFF	ON	Zones 9 - 12
	OFF	OFF	ON	Zones 13 - 16
	ON	ON	OFF	Zones 17 - 20
	OFF	ON	OFF	Zones 21 - 24
	ON	OFF	OFF	Zones 25 - 28
	OFF	OFF	OFF	Zones 29 - 32

The following is a diagram of the zone expander and where the jumper switches are located.

! *There are two sets of jumpers, one set for the first 4 zones of the expander and one set for the other 4 zones.*

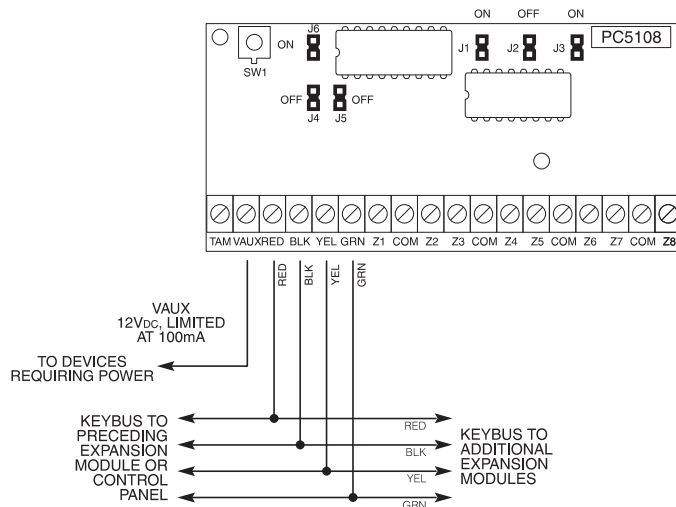

In the above diagram the jumper settings shown indicate the first group of four zones of the expander will be zones 9 to 12 and the second group of 4 zones will be 13 to 16.

A group of zones can be disabled if they are not required for the installation.

2.6 Keypad Assignment

There are 8 available slots for keypads. LED keypads by default are always assigned to slot 1 while the LCD5500 is always assigned to slot 8. Keypads can each be assigned to a different slot (1 to 8) which offers two advantages. The panel can supervise the keypad connection to indicate a trouble condition if it is removed. Also keypads can be assigned to operate a specific partition or operate as a global keypad.

2.6.1 How to Assign Keypads

! *All keypad assignment must be done individually on each keypad on the system.*

To assign a keypad to a slot and select the partition it will operate, enter the following:

Step 1 — Enter Installer Programming

Step 2 — Press [000] for Keypad Programming

Step 3 — Press [0] for Partition and Slot Assignment

Enter a two digit number to specify the partition and slot assignment.

1st digit Enter 0 for Global Keypad;
 Enter 1 for Partition 1 Keypad;
 Enter 2 for Partition 2 Keypad

2nd digit Enter 1 to 8 for Slot Assignment

Press the [#] key twice to exit programming. Continue this procedure at each keypad until all have been assigned to the correct slot.

2.6.2 How to Program Function Keys

Each of the 5 Function Keys on each keypad may be programmed for different operation on each keypad.

Step 1 - Enter Installer Programming.

Step 2 - Press [000] for Keypad Programming.

Step 3 - Enter [1] to [5] to select Function Key to program.

Step 4 - Enter the 2 digit number, [00] to [17] for option.

Step 5 - Continue from Step 3 until all Function Keys are programmed.

Step 6 - Press [#] to exit Installer Programming.

For a complete list of Function Key options See Section 3.5.1 "Function Key Options".

2.7 Enable Supervision

Once all the Keybus connections have been made, supervision must be enabled so the panel can indicate a trouble if a module is removed from the system.

To enable supervision, enter the following at any keypad:

Step 1 - Press [*] [8] [Installer Code] to enter Installer Programming.

Step 2 - Press [902] to enable supervision. The panel will automatically search for all modules on the system. Once the search (it will take about 1 minute) is complete enter the following to confirm the modules on the system.

Step 3 - Press [903] to display all modules.

Zone lights will be turned on according to what modules the panel has found on the system. The LCD keypad will allow you to scroll through the modules. Refer to the following chart:

Light [1]	Keypad 1 present	Light [13]	Zones 25 to 28 present
Light [2]	Keypad 2 present	Light [14]	Zones 29 to 32 present
Light [3]	Keypad 3 present	Light [15]	N/A (not used)
Light [4]	Keypad 4 present	Light [16]	N/A (not used)
Light [5]	Keypad 5 present	Light [17]	N/A (not used)
Light [6]	Keypad 6 present	Light [18]	Module PC5208 present
Light [7]	Keypad 7 present	Light [19]	Module PC5204 present
Light [8]	Keypad 8 present	Light [20]	Module PC5400 present
Light [9]	Zones 9 to 12 present	Light [21]	Module PC5928 present
Light [10]	Zones 13 to 16 present	Light [22]	N/A
Light [11]	Zones 17 to 20 present	Light [23]	N/A
Light [12]	Zones 21 to 24 present	Light [24]	Escort5580 module present

If a module is connected but does not show as being present, it may be due to any of the following reasons:

- it is not connected to the Keybus
- if there is a Keybus wiring problem
- if the module is more than 1,000'/330m from the panel
- if the module does not have enough power

2.8 Removing Modules

If a module is no longer required on the system the panel must be told to no longer supervise the module. To do this remove the module from the Keybus and perform the Enable supervision function again (See Section 2.7 "Enable Supervision"). The panel will see the module has been removed and will no longer supervise it.

2.9 Zone Wiring

There are several different ways in which zones may be wired, depending on the programming options selected.

! *Any zone defined as a Fire zone will automatically require a single End of Line (EOL) resistor regardless of which type of zone wiring supervision is selected (See Section 5.1 “Zone Definitions”).
When reconfiguring the zone supervision from a non-default setting – such as DEOL to EOL, NC to DEOL or disabling zones 1-8 while open or in trouble – the system should be powered down completely and powered up again.*

2.9.1 Normally Closed (NC) Loops

Wire all zones according to the following diagrams:

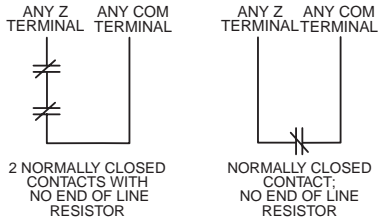

! *This option can only be selected if Normally Closed (NC) detection devices or contacts are being used.*

2.9.2 Single End Of Line (EOL) Resistors

Wire all zones according to the following diagrams:

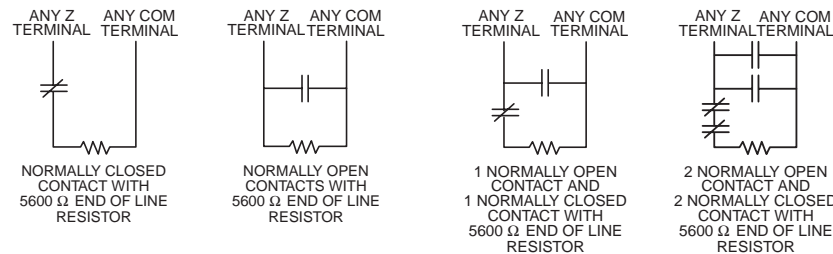

! *This option can be selected if either Normally Closed (NC) or Normally Open (NO) detection devices or contacts are being used.*

2.9.3 Double End of Line (DEOL) Resistors

Double EOL loops allow the panel to determine if the zone is in alarm, tampered or faulted. Wire the zones according to the following diagram:

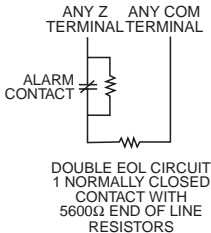

! *This option can only be selected if Normally Closed (NC) detection devices or contacts are being used.
Only one NC contact can be connected to each zone, multiple detection devices or contacts on one loop is not allowed.*

The following chart shows the status of the zone under certain conditions:

Loop Resistance	Loop Status
5600Ω (contact closed)	Secure
11200Ω (contact open)	Violated
0Ω (shorted wire, loop shorted)	Fault
Infinite (broken wire, loop open)	Tamper

2.9.4 Fire Zone Wiring - 4 wire Smoke Detectors

All zones defined as Fire (See Section 5.1 "Zone Definitions") must be wired according to the following diagram:

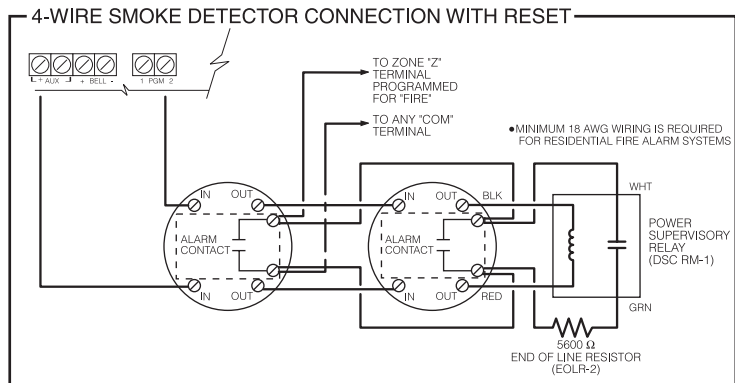

! Do not use double EOL resistors for Fire zones.

For a complete description of how fire zones operate, see Section 5.1 "Zone Definitions".

2.9.5 Keyswitch Zone Wiring

Zones may be programmed to be used as keyswitch arming zones and must be wired according to the following diagrams:

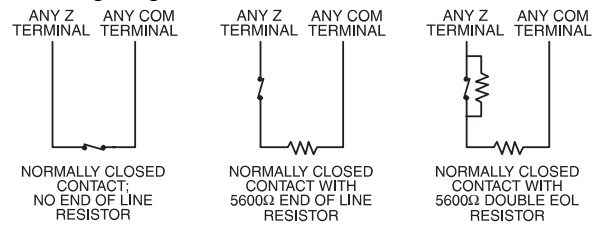

For a complete description of how keyswitch zones operate, see Section 5.1 "Zone Definitions".

Keypad Commands

S E C T I O N 3

All keypads provide complete information and control of the alarm panel. The panel can be completely programmed via any keypad on the system. LED keypads provide function indicator lights and individual zone indicator lights for the alarm circuits. The LCD keypad provides function indicator lights and word descriptions for zone status.

The following sections describe how to arm, disarm and perform other keypad functions.

3.1 Access Codes

The panel has a total of 37 Access Codes available.

- Access Codes [01] to [32] .. User Codes 1 to 32
- Access Code [33] Partition 1 Duress Code
- Access Code [34] Partition 2 Duress Code
- Access Code [40] System Master Code
- Access Code [41] Partition 1 Master Code
- Access Code [42] Partition 2 Master Code

System Master Code

The **System Master Code Not Changeable** option can be used to lock in the code. This will prevent the user from being able to change the System Master Code. If they attempt to change the code the keypad will sound a long error beep. The System Master Code can be used to arm or disarm any partition and perform any keypad function.

If the code is lost it can be reprogrammed through Installer Programming.

.....

System Master Code Not Changeable Section [015], Option [6]

System Master Code Section [007]

.....

Partition Master Codes

By default the Partition Master Codes are not programmed. They must be programmed by the System Master Code. A Partition Master, once programmed, can be used to arm and disarm the Partition it is assigned to. In addition, a Partition Master can program the 32 User Codes to operate on the Partition it is assigned to and program the Partition Duress Code.

Partition Duress Codes

By default Partition Duress Codes are not programmed. They must be programmed by the System Master Code or the Partition Master Code for that Partition. Once programmed if the Duress Code is used any time, the panel will activate a silent Duress alarm (See Section 5.7 "Communicator - Reporting Codes").

User Codes

By default the 32 User Codes are not programmed. They must be programmed by the System Master Code or Partition Master Code. Once programmed the User Code can be used to arm or disarm any Partition it is enabled for. In addition, each User Code can be enabled or disabled for bypass ability (See Section 3.4 "[*] Commands, [*] [1] Zone Bypass").

Maintenance Code

The Maintenance Code is an access code that can only arm/disarm the panel. It cannot be used to bypass zones. This code cannot be used to access the system by the Escort5580. The code can be used for service personnel.

.....

Maintenance Code Section [008]

.....

3.2 Arming /Disarming

The system cannot be armed unless the 'Ready' light is on. If the 'Ready' light is not on make sure all protected doors and windows are secure and stop movement in areas covered by motion detectors. When the 'Ready' light is on enter any valid Access Code. As each digit is pressed the keypad will beep. If an incorrect code is entered the keypad will emit a steady 2 second beep to indicate the code was not correct. If the code is correct but the 'Ready' light was not on the panel will beep six times rapidly followed by a long two second beep to indicate the system was not Ready. When the correct code is entered and the system is Ready the panel will beep six times rapidly and the 'Armed' light will turn on. Exit the premises through the designated entry/exit door. Other methods of arming are available (See Section 3.4 "[*] Commands - [*] [0] Quick Arm, [*] [9] Arming Without Entry Delay" and Section 3.5 "Function Keys").



The PC5016 has a built-in feature called Audible Exit Fault. See Section 5.15 "Entry/Exit Delay Options for more information.

To disarm the panel enter the premises through the designated entry/exit door. The keypad will emit a steady beep to warn that you must disarm the system. During the last 10 seconds of entry delay the panel will pulse the keypad beeper on and off rapidly to warn the entry delay is about to expire. Enter a valid Access Code at the keypad. If an error is made press the [#] key and enter the code again. When a correct code is entered the keypad will turn off the 'Armed' light and stop the keypad buzzer. If an alarm occurred while the panel was armed the 'Memory' light and the zones which caused the alarm will be flashing. Press the [#] key to return the keypad to the Ready state.

3.3 Auto Bypass

When the system is armed and any zone or zone(s) on the system have been programmed as Stay/Away the panel will immediately turn on the 'Bypass' light. It will then monitor all zones programmed as Delay 1 and Delay 2. If no delay type zone is violated by the end of the exit delay the panel will bypass all Stay/Away type zones. The 'Bypass' light will remain on to inform the home owner that the interior protection has been automatically bypassed by the panel. If a delay zone is violated during the exit delay, the Stay/Away zones will be active after the exit delay expires.

This is a convenience for the user that wishes to arm the panel while at home. The user does not have to bypass the interior manually.

The user can add the Stay/Away zones back into the system at any time by entering the [*] [1] keypad command (See Section 3.4 "[*] Commands, [*][1] Zone Bypass").

Other methods of Stay arming are available (See Section 3.5 "Function Keys").

3.4 [*] Commands

[*]+[1] Zone Bypass/Reactivate Stay/Away Zones

The [*] [1] keypad command can be used to bypass individual zones. It can be used if the user wants to have access to an area while the Partition is armed or to bypass a defective zone (bad contact, damaged wiring) until service can be provided.

A Partition can be armed with a bypassed zone. A bypassed zone will not cause an alarm.

If **Code Required for Bypass** is enabled an access code will be required to enter the Bypass mode. Only user codes with the Bypass attribute enabled will be able to bypass zones (See Section 3.4 "[*] Commands, [*] [5]").



Zones can only be bypassed when the partition is disarmed.

To bypass a zone:

1. Enter [*] [1] (access code if required).
2. The keypad will flash the 'Bypass' light and turn on the zone lights for any zones already bypassed.
3. Enter the 2 digit zone number to bypass the zone.
4. The keypad will turn on the zone light.
5. Press [#].

All zones that were lit when the [#] key was pressed are now bypassed. The 'Bypass' light will be on steady to indicate zones are bypassed.

To un-bypass a zone:

1. Enter [*] [1] (access code if required).
2. The keypad will flash the 'Bypass' light and turn on the zone lights for any zones already bypassed.
3. Enter the 2 digit zone number to un-bypass the zone.
4. The keypad will turn off the zone light.
5. Press [#].

All zones that were lit when the [#] key was pressed are now bypassed. If no zones were lit, the 'Bypass' light will be off and no zones will be bypassed.



When a Partition is disarmed all manually bypassed zones will be un-bypassed.

Reactivate Interior

If a Partition is armed in the Stay mode (See Section 3.2 "Arming/Disarming"), the [*] [1] command can be used to reactivate the Stay/Away zones.



Please ensure all force-armed zones are restored before reactivating the Stay/Away zones.

.....
 Code required for bypass - section [015], option [5]

[*]+[2] Trouble Display

The panel constantly monitors itself for several different trouble conditions. If a trouble condition is present the 'Trouble' light will be on steady and all keypads will beep twice every 10 seconds.



The trouble beep can be silenced by pressing any key on any keypad.

To view trouble conditions:

1. Press [*] [2].
2. The keypad will flash the 'Trouble' light and light zones to indicate which trouble conditions are present. A description of the various troubles are as follows:

Trouble [1] - Service Required

This light will be on if any of the following trouble conditions are detected by the control panel; Low Battery, Bell Circuit Trouble, General System Trouble, General System Tamper, General System Supervisory, PC5204 Low Battery and PC5204 AC Failure.

If a 'Service Required' trouble is present press [1] to determine the specific trouble present. The following is a list of the specific 'Service Required' trouble conditions:

- Light [1] - Low Battery
The main panel backup battery is low. The trouble will be generated if the battery drops below 11.5 volts under load and will restore when the battery charges over 12.5 volts.
- Light [2] - Bell Circuit Trouble
The panel will indicate this trouble if the Bell fuse is blown or the panel senses an open condition on the bell circuit (See Section 5.12 "Siren Supervision").
- Light [3] - General System Trouble
This trouble will be present if the PC5204 Power Supply module has an AUX failure, PC5204 Output #1 Trouble, or a printer connected to the PC5400 Printer module has a fault (off-line).
- Light [4] - General System Tamper
This trouble will be indicated if a Tamper Zone violation on any module is detected.
- Light [5] - General System Supervisory
This trouble will be indicated if the panel loses communication with any module connected to the Keybus (See Section 2.7 "Enable Supervision"). The event buffer will log a detailed description of the event.
- Light [6] - Not Used
- Light [7] - PC5204 Low Battery
The PC5204 module has a low backup battery.
- Light [8] - PC5204 AC Failure
The PC5204 module has lost AC power.

Trouble [2] - AC Failure

This trouble indicates that AC power is no longer being supplied to the control unit. If it is required to communicate this to a monitoring station, program reporting codes in sections [349] and [350]. To inhibit reporting of short duration power outages, a delay can be programmed in section [370].

Trouble [3] - Telephone Line Trouble

The telephone connection to the control unit is continuously monitored. If there is a problem with the telephone connection, a trouble will be indicated after the delay programmed in section [370].

Trouble [4] - Failure to Communicate (FTC)

If the communicator fails in an attempt to communicate with any of the programmed telephone numbers, this trouble will be generated. If a later attempt is successful, the FTC reporting code(s) programmed in section [351] will be transmitted along with any other unreported events that occurred while the panel was not able to communicate.

Trouble [5] - Zone Fault (including Fire Zone)

This trouble will be indicated if any zone on the system is in a trouble condition, i.e. it could not provide an alarm to the panel if required to do so. When a trouble condition occurs, the keypad(s) on the affected partition will start to beep.

Press [5], while in Trouble mode, to view which zones have a trouble condition.

Trouble [6] - Zone Tamper

This trouble is only generated by zones configured for double EOL resistor supervision. This trouble is generated when a tamper condition is present. When a tamper condition occurs, the keypad(s) on the affected partition will start to beep.

Press [6], while in Trouble mode, to view which zones have a tamper condition.

Trouble [7] - For future use

Trouble [8] - Loss of System Time

This trouble occurs when the control unit is powered up and the internal clock has not been set. Setting the time with User Function [*][6][Master Code][1] will clear this trouble.

[*]+[3] Alarm Memory

The 'Memory' light will be on if any alarm occurred during the last armed period or if an alarm occurred while the panel was disarmed (24 hour zones).

To view alarm memory:

1. Press [*] [3].
 2. The keypad will flash the Memory light and light up zone lights to indicate alarm or tamper conditions that occurred during or since the last armed period.
- When the panel is armed the 'Memory' light will go out.

[*]+[4] Doorchime On/Off

If enabled the keypad will beep 5 times rapidly when a zone is tripped and restored. The panel will only do this for zones with the Doorchime attribute enabled and if the Doorchime feature is enabled (See Section 5.2 "Zone Attributes").

To turn Doorchime on/off:

1. Press [*] [4].
2. The keypad will beep 3 times rapidly when the Doorchime feature is enabled and one long beep when the feature is disabled.

[*]+[5] Programming Access Codes

There are 37 Access Codes available. They are as follows:

- Access Code [01] to [32] . User Codes 1 to 32
- Access Code [33] Partition 1 Duress Code
- Access Code [34] Partition 2 Duress Code
- Access Code [40] Master Code
- Access Code [41] Partition 1 Master Code
- Access Code [42] Partition 2 Master Code

All Access Codes have the ability to arm/disarm any Partition(s) it is enabled for and activate the PGM Outputs using the [*] [7] [1] [Access Code] and [*] [7] [2] commands (See Section 3.4 "[*] Commands, [*][7]").

Additional Access Code Attributes are also programmable. Attributes determine what abilities the code will have. The programmable attributes are as follows:

- Partition 1 Operation enable
- Partition 2 Operation enable
- Zone Bypass enable

User Codes - Access Codes [01] to [32]

Each User Code can be programmed to work on Partition 1, Partition 2 or both Partitions. In addition each can be programmed to have the ability to bypass zones.



"Master Code" attributes cannot change. By default, each code has the attributes of the code used to program it.

Duress Codes - Access Codes [33] and [34]

When a Duress Code is used to perform any function the panel will report a Duress Reporting Code (See Section 5.7 "Communicator - Reporting Codes").

Partition Master Codes - Access Codes [41] and [42]

Partition Master Codes can program additional User Codes and the Duress Code for their Partition.

System Master Code - Access Code [40]

By default the System Master Code is enabled to operate on both Partitions and can perform any keypad function. This code can be used to program all User Codes as well as the Partition Master Codes and Duress Codes.

If the **Master Code Not Changeable** option is enabled the System Master Code can only be changed using Installer Programming.

How to program Access Codes:

Programming Access Codes is a two step process. First the Code must be programmed followed by the Code Attributes.

1. Enter [*] [5] [Master Code]. The keypad will flash the 'Program' light and turn on the zone light for any code already programmed.
2. Enter the 2 digit number for the code you want to program. The corresponding zone light will flash.
3. Enter a 4 digit code. The zone light will turn on steady.
4. Continue with steps 2 and 3 until all codes are programmed.



Do not press [*] or [#] when programming the 4 digit code. When programming Duress Codes or Partition Master Codes no zone light will flash.

After all the Codes have been programmed press the [#] key to return to the Ready mode.

How to program Access Code Attributes:

! *“Master Code” attributes cannot change. By default, each code has the attributes of the code used to program it.*

1. Enter [*][5][Master Code]. The keypad will flash the ‘Program’ light and turn on the zone light for any code already programmed.
 2. Press [9] to enter the Attribute mode. The keypad will turn on the ‘Ready’ light and turn off the armed light.
 3. Enter the 2 digit number for the code you want to program Attributes for. Zone lights [1] to [4] will be on or off. Refer to the following chart:
 - Zone Light 1 - ON - enable code for Partition 1
 - Zone Light 2 - ON - enable code for Partition 2
 - Zone Light 3 - ON - enable Zone Bypass
 4. Enter [1] to [3] to turn the zone lights ON or OFF, then press [#] key.
 5. Continue with steps 2 and 3 until all code attributes are programmed.
- After all the codes and attributes have been programmed press the [#] key to exit Access Code Programming.

How to erase Access Code:

Select the code to be erased and press [*].

[*]+[6] User Functions

This keypad command can be used to program several different functions. The following are the items programmable:

- [1] - Time and Date
- [2] - Auto-Arm Enable *
- [3] - Auto-Arm Time *
- [4] - System Test
- [5] - Enable DLS (Downloading)
- [6] - For future use
- [7] - Enable background music

Auto-Arm items (noted with the “*” symbol) are programmable by Partition. These must be programmed at a keypad assigned to the correct Partition (See Section 2.6 “Keypad Assignment”).

To program User Functions:

1. Press [*] [6] [Master Code]. The keypad will flash the ‘Program’ light.
2. Press the number [1] to [5] for the item to be programmed.

- [1] - Time and Date

The time and date must be accurate for the Auto-Arm or Test Transmission functions to work properly. In addition the event buffer time and date stamps all events.

- Enter the time: hour and minute, using military format [HH MM]. (00:00 to 23:59)
- Enter the date: month, day and year [MM DD YY].

! *All entries must be 2 digits. January, for example, would be month [01].*

- [2] - Auto-Arm Enable/Disable

Auto-Arming will not work until it is enabled for the Partition.

Press [2]. If the keypad beeps 3 times rapidly Auto-Arm is enabled, one long beep means it is disabled.

- [3] - Auto-Arm Time

Each Partition can be programmed to Auto-Arm at a different time.

Enter the time, hour and minute, using military format [HH MM].

! *All entries must be 2 digits. Eight o’clock in the morning would be [08] hours and [00] minutes.*

- [4] - System Test

When [4] is pressed the panel will perform the following:

- sound the alarm output for two seconds
- light all lights on the keypad
- sound the keypad buzzer for two seconds
- test the main panel/PC5204 battery
- send a System Test Reporting code, if programmed (See Section 5.7 “Communicator - Reporting Codes”).

- [5] - Enable DLS (Downloading)

When [5] is pressed the panel will turn on the downloading option for 6 hours. During this time the panel will answer incoming downloading calls (See Section 5.8 “Downloading”).

- [6] - For future use

- [7] - Enable Background Music
If the intercom is being used to provide background music, press the [7] key to toggle the background music feature on and off.



Additional Features are available using on the LCD keypad. These features do not have numbers assigned. Use the arrow keys (<>) to scroll through the [*] [6] menu and press the [*] key to select the following commands.

View Event Buffer

The 256 event buffer can be viewed through any LCD keypad (See Section 5.16.1 “Viewing the Event Buffer Through the LCD Keypad”).

Brightness Control

When this option is selected the keypad will allow you to scroll through 10 different backlight level options. Use the arrow keys (<>) to scroll to the desired backlight level and press the [#] key to exit.

Contrast Control

When this option is selected the keypad will allow you to scroll through 10 different contrast level options. Use the arrow keys (<>) to scroll to the desired contrast level and press the [#] key to exit.

Keypad Buzzer Control

When this option is selected the keypad will allow you to scroll through 21 different keypad sounder tone options. Use the arrow keys (<>) to scroll to the desired keypad beeper level and press the [#] key to exit. This function can be achieved on LED keypads by holding the [*] key.

[*]+[7] Output Functions

Two Output Functions can be performed at a keypad. They are Utility Output and Smoke Detector Reset.

To activate Utility Output:

Press [*] [7] [1][Access Code].

The panel will activate all PGM Outputs for 5 seconds programmed as Utility Output for that Partition (See Section 5.10 “PGM Outputs”).

To activate Smoke Detector Reset:

Press [*] [7] [2].

The panel will activate all PGM Outputs for 5 seconds programmed as Sensor Reset.

[*]+[8] Installer Programming

Enter [*][8] followed by the Installer Code to enter Installer Programming (See Section 4.0 “How to Program”).

[*]+[9] Arming Without Entry Delay

When a Partition is armed with the [*][9] command the panel will remove the entry delay from the partition. After the exit delay, Delay 1 and Delay 2 type zones will be instant and Stay/Away zones will remain bypassed. (See Section 5.1 “Zone Definitions”).

A valid access code must be entered after pressing [*] [9].

[*]+[0] Quick Arm/Quick Exit

Quick Arm

If the Quick Arm Enable option is enabled the panel can be armed by entering [*][0]. This is a useful method of arming a Partition when someone without a User Code will be required to arm a Partition.

Quick Exit

Quick Exit will allow someone to leave an armed premise through a Delay type zone without having to disarm and rearm the system.

When [*][0] is entered, if the Quick Exit Enabled option is enabled, the panel will provide a two minute window to exit. During this time the panel will ignore the first activation of a Delay type zone. When the Delay zone is secured the panel will end the two minute time period.

If a second Delay zone is tripped, or if the zone is not restored after two minutes, the panel will start entry delay.



If Quick Exit is used on a partitioned system, Keypad Blanking and Access Code Required to Remove Blanking should be enabled.

Code Required for Bypass	Section [015], Option [5]
Master Code Not Changeable option	Section [015], Option [6]
Quick Arm Enable	Section [015], Option [4]
Quick Exit Enable	Section [015], Option [3]

3.5 Function Keys

There are 5 function keys on the PC5016 keypads labelled Stay, Away, Chime, Reset and Exit. The operation of these keys is described below. The function is activated by pressing and holding the key for 2 seconds.

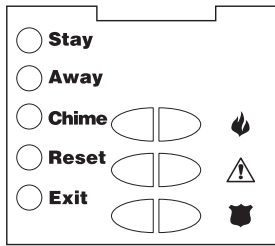

“Stay” - Stay Arm

Arms the partition to which the keypad is assigned. All Stay/Away type zones will be automatically bypassed. Delay type zones will provide entry and exit delay. The Quick Arm feature must be enabled for this key to function.

“Away” - Away Arm

Arms the partition to which the keypad is assigned. All Stay/Away type zones will be active at the end of the exit delay. Delay type zones will provide entry and exit delay. The Quick Arm feature must be enabled for this key to function.

“Chime” - Doorchime On/Off

Pressing the key will toggle the Doorchime feature ON or OFF. One solid beep means the feature has been disabled, three short beeps means it has been enabled.

“Reset” - Reset Smoke Detectors

Pressing this key will cause the panel to activate for 5 seconds any output programmed as Sensor Reset. In addition 2-wire smoke detectors connected to PGM2 will also be reset (See Section 3.4 “[*] Commands, [*][7][2]”).

“Exit” - Activate Quick Exit

Pressing this key will cause the panel to activate the Quick Exit feature (See Section 3.4 “[*] Commands, [*][0]”).

3.5.1 Function Key Options

The following is a list of Function Key options available:

[00] - Null Key

The key is not used and will perform no function when pressed.

[01] - Select Partition 1

Provides an easy way to select Partition 1 operation from a Partition 2 keypad. This is the same as pressing and holding the [#] key then pressing and holding the [1] key to select Partition 1 from a Partition 2 keypad (See Section 3.6 “Global and Partition Keypad Operation”).

[02] - Select Partition 2

Provides an easy way to select Partition 2 operation from a Partition 1 keypad. This is the same as pressing and holding the [#] key then pressing and holding the [2] key to select Partition 2 from a Partition 1 keypad (See Section 3.6 “Global and Partition Keypad Operation”).

[03] - Stay Arm

Same as described in Function Keys - Section 3.5.

[04] - Away Arm

Same as described in Function Keys - Section 3.5.

[05] - [*]+[9] No-Entry Delay Arm

After this function key is pressed the user must enter a valid user code. The Partition will arm and remove entry delay from the partition when the exit delay expires (See Section 3.4 “[*] Commands, [*] [9] Arming without entry delay”).

[06] - [*]+[4] Doorchime On/Off

This function key provides the user a simple method for turning the Doorchime feature on and off (See Section 3.4 “[*] Commands, [*] [4] Doorchime on/off”).

[07] - [*]+[6]...[4] System Test

This function key provides the user with a simple method for testing the system (See Section 3.4 “[*] Commands, [*] [6] User functions”).

[08] - [*]+[1] Bypass Mode

This function key provides the user with a simple method for entering the Bypass Mode. If a user code is required it must be entered before bypassing can be performed (See Section 3.4 "[*] Commands, [*] [1] Zone Bypass").

[09] - [*]+[2] Trouble Display

This function key provides the user with a simple method for entering the Trouble Display Mode (See Section 3.4 "[*] Commands, [*]+[2] Trouble display").

[10] - [*]+[3] Alarm Memory

This function key provides the user with a simple method for entering the Alarm Memory Display Mode (See Section 3.4 "[*] Commands, [*] [3] Alarm memory").

[11] - [*]+[5] Programming Access Codes

This function key provides the user with a simple method for programming user codes. After this key is pressed a valid System Master or Partition Master will have to be entered before the panel will allow programming to be performed (See Section 3.4 "[*] Commands, [*] [5] Programming Access Codes").

[12] - Global Arming (Away Arm)

This function key provides the user with a simple method for arming both partitions at the same time. All Stay/Away-type zones will be activated at the end of the exit delay. Delay-type zones will provide entry and exit delays. The Quick Arm feature must be enabled for this key to function. **NOTE: This function key will not work on a keypad that is in the global mode.**

[13] - [*]+[7]+[1] Utility Output

This function keys provides the user with a simple method for activating a PGM Output programmed as Utility Output (See Section 5.10 "PGM outputs"). After this key is pressed a valid user code must be entered (See Section 3.4 "[*] Commands, [*] [7] Utility output functions").

[14] - [*]+[7]+[2] Smoke Detector Reset

Same as described in Function Keys - Section 3.5.

[15] - General Voice Prompt Help

For use with a LED keypad, if both the Escort5580 and the PC5928 intercom module are being used, audio help can be provided by programming one of the function keys as option [15]. When the function key is pressed, the intercom will perform a Help page. The user must then press the Page/Answer button on the intercom station to terminate the help session. For more information, please refer to the PC5928 Installation Manual.

[16] - [*]+[0] Quick Exit

Same as described in Function Keys - Section 3.5.

[17] - [*]+[1] Reactivate Stay/Away Zones

This function key provides the user with a simple method for adding Stay/Away zones back into the system at night-time (See Section 3.4 "[*] Commands, [*] [1] Reactivate Stay/Away zones").

[18] Identified Voice Prompt Help

For use with a LCD keypad, this feature operates similar to option [15] except that the ESCORT will begin to announce status of the system through the intercom station closest to the keypad. In order for this option to operate correctly, you must program which intercom station is closest to each keypad in the PC5928 programming sections. For more information, please refer to the PC5928 Installation Manual.

3.6 Global and Partition Keypad Operation

A global keypad will not display any information (the trouble LED will light if a trouble condition is present) until a partition is selected. To select a partition the user must press and hold the [1] key for Partition 1 or the [2] key for Partition 2 for two seconds. The keypad will then display the status of the selected partition and allow normal operation.

A Partition keypad will display the status of the Partition for which it has been programmed. A user with access to both partitions may temporarily assign the keypad to the other partition to gain access. To do this the user must first press and hold the [#] key for two seconds. The keypad will go blank. The user must then press and hold the [1] key for Partition 1 or the [2] key for Partition 2 for two seconds. The keypad will then display the status of the selected partition and allow normal access.

How to Program

S E C T I O N 4

The following section of the manual describes how to enter Installer Programming and how to program the various sections.

! *It is extremely important that you read the following section of the manual to completely understand how to program the panel.*

4.1 How to Enter Installer Programming

Installer Programming is used to program all communicator and panel options. The **Installer Code** is [5016] at default but may be changed to prevent unauthorized access to programming.

LED Keypad

Step 1 From any keypad enter [*][8][Installer Code].

- The 'Program' light will flash to indicate you are in programming
- The 'Armed' light will turn on to indicate the panel is waiting for the 3 digit section number to program

Step 2 Enter the 3 digit section number you want to program.

- The Armed light will turn off
- The Ready light will turn on to indicate the panel is ready for the information for the selected section

! *If the 3 digit section number entered is not valid or the module that pertains to the section is not present the keypad will sound a 2 second beep or error tone.*

LCD Keypad

Step 1 From any keypad enter [*][8][Installer Code].

The Keypad will display 'Enter Section' followed by three dashes.

Step 2 Enter the 3 digit section number you want to program.

The keypad will now display information for the section entered.

.....
Installer Code Section [006]
.....

4.2 Programming Decimal Data

When the Ready light is ON the panel is waiting for the information to be programmed for the selected section. Enter the information written in the boxes for the section found in the Programming Worksheets. If a digit is entered for each program box in a section the panel will automatically exit from the section. It will turn OFF the Ready light and turn the Armed light back ON.

You can also press the [#] key to exit a section before entering data for every box. This is handy if you only need to change the first few program boxes. All other locations in the section will remain unchanged. If the [#] key is pressed the panel will turn OFF the Ready light, turn ON the Armed light and exit you from the section.

4.3 Programming HEX Data

On occasion, hexadecimal (HEX) digits may be required. To program a HEX digit press the [*] key. The panel will enter HEX programming and Ready light will begin to flash.

The following table indicates which number should be pressed to enter the corresponding HEX digit:

1 = A 2 = B 3 = C 4 = D 5 = E 6 = F

After the correct HEX digit is entered the Ready light will continue to flash. If another HEX digit is required press the corresponding number. If a decimal digit is required press the [*] key again. The Ready light will turn on solid and the panel will return to regular decimal programming.

! *It is important to watch the Ready light. If the light is flashing any number you enter will be programmed as the HEX equivalent.*

Example: To enter 'C1' for a closing by user 1, you would enter [*] [3] [*], [1]

[*] to enter Hexadecimal mode (Ready light flashes)

[3] to enter C

[*] to return to decimal mode (Ready light is solid)

[1] to enter digit 1

If you enter information into a section and make a mistake, press the [#] key to exit the section. Select that section again and re-enter the information correctly.

If you are using a pulse format, a decimal zero [0] does not transmit. Programming a zero [0] tells the panel not to send any pulses for that digit. Decimal zero [0] is a filler digit. To make a zero [0] transmit, it must be programmed as a Hexadecimal 'A'.

Example: for the three digit account number '403', you would enter [4], [*] [1] [*] [3], [0].

- [4] to enter the digit 4
- [*] to enter Hexadecimal mode (Ready light flashes)
- [1] to enter A
- [*] to return to decimal mode (Ready light is solid)
- [3] to enter the digit 3
- [0] to enter the digit 0 as a filler digit.

4.4 Programming Toggle Option Sections

Some sections contain several toggle options. The panel will use zone lights 1 through 8 to indicate if the different options are enabled or disabled. Refer to the Programming Worksheets to determine what each option represents and whether the light should be ON or OFF for your application.

Press the number corresponding to the option to toggle the light ON or OFF.

Once all the toggle options have been selected correctly press the [#] key to exit the section and save the changes. The panel will turn off the Ready light and turn on the Armed light.

4.5 Viewing Programming

4.5.1 LED Keypads

Any program section can be viewed through the keypad. When a section is entered the keypad will immediately display the first digit of information programmed in that section.

The keypad displays the information using a binary format where:

- Zone Light 1 = 1
- Zone Light 2 = 2
- Zone Light 3 = 4
- Zone Light 4 = 8

Add up the values for the zone lights to determine the number displayed (for example, no zone lights = 0, all 4 zone lights = 15 HEX 'F').

Press any of the Emergency Keys (Fire, Auxiliary or Panic) to advance to the next digit. When all the digits in a section have been viewed the panel will exit the section, turn off the Ready Light, turn on the Armed light and wait for the next three digit section number to be entered. If the [#] key is pressed the panel will also exit the section.

4.5.2 LCD Keypads

Any program section can be viewed through the keypad. Depending on the section entered, the LCD will display the information differently as below:

Sections Entered	LCD Display
Phone number	Entire phone number
Partition identifier code	Entire partition identifier code
Toggle option	Entire section (all options)
Reporting code	Each 2-digit reporting code at a time

Use the arrow keys (<>) to scroll through the data being displayed.

Scroll past the end of the data displayed or press the [#] key to exit the section.

Program Descriptions

S E C T I O N 5

The following section explains all the programmable features including how the feature operates, options that pertain to the feature and a summary of program locations that require programming.

5.1 Zone Definitions

These sections will allow you to select how each of the 32 zones will operate. Each zone requires a 2 digit entry.



In addition to selecting how each zone will operate, attributes may be programmed by zone (See Section 5.2 "Zone Attributes").

[00] Null Zone

The zone will not operate in any way. Zones that are not used should be programmed as Null zones.

[01] Delay 1 Zone

If this zone is violated when the panel is armed it will provide entry delay. The keypad buzzer will sound to warn the user that the system must be disarmed. If the panel is not disarmed before the entry delay expires an alarm will be generated. Typically this type of zone will be used for the front door, back door or any other entry/exit point. Refer to Section [005], "System Times", to program the Delay 1 zone entry delay time.

[02] Delay 2 Zone

This zone type operates the same as the Delay 1 zone option but can provide a different entry delay. Typically this zone will be used for a garage door. Refer to Section [005], "System Times", to program the Delay 2 zone entry delay.

[03] Instant Zone

If this zone type is violated when the panel is armed it will cause an instant alarm. Typically this zone is used for windows, patio doors or other perimeter type zones.

[04] Interior Zone

If this type of zone is violated when the panel is armed it will provide entry if a delay type zone was violated first. Otherwise it will cause an instant alarm. Typically this zone is used for interior protection devices, such as motion detectors.

[05] Interior Stay/Away Zone

This zone type works the same as the Interior zone type with one exception. The zone will be automatically bypassed under the following conditions:

- the panel is armed in the Stay Mode (See Section 3.5 "Function Keys")
- the panel is armed without entry delay (See Section 3.4 "[*] Commands, [*][9]")
- the panel is armed and during the exit delay a Delay type zone is NOT tripped

The automatic bypass avoids having the user manually bypass interior type zones when arming at home. If automatically bypassed, the user can reactivate the zones by entering the [*][1] command (See Section 3.4 "[*] Commands, [*][1] Zone Bypass"). Typically this zone is used for interior protection devices, such as motion detectors. Stay/Away zones should not be programmed as global zones.

[06] Delay Stay/Away Zone

This zone type will operate the same as the Interior Stay/Away zone type except that it will always provide entry delay. Typically this zone is used for interior protection devices, such as motion detectors and will help prevent false alarms since it will always provide the user the entry delay time to turn off the panel. Stay/Away zones should not be programmed as global zones.

[07] Delayed 24 Hour Fire Zone

If this zone is violated the alarm output will immediately activate but the communicator will be delayed for 30 seconds. If during the 30 second delay the user presses any key on any keypad the alarm output and communicator will be delayed an additional 90 seconds, providing the user time to correct the problem. If after the 90 second delay the zone is still violated the process will begin again; the alarm output will be activated but the communication will be delayed 30 seconds...

If the user does not press a key, after 30 seconds the alarm output will latch and the panel will communicate. The alarm will sound for the Bell Cutoff time programmed in Section [005], "System Times" or can be programmed to sound until a valid code is entered, Section [014], "Second System Option Code, option [8]".



If a second Fire type zone is violated or the Fire keys are pressed during the delay time the panel will latch the alarm output and communicate immediately.

If a delayed Fire zone is violated it will be displayed on all keypads and can be delayed at any keypad. Typically this zone is used for latching smoke detectors.

- [08] Standard 24 Hour Fire Zone**
When violated the panel will immediately latch the alarm output and communicate to central station. The alarm will sound for the Bell Cutoff time programmed in *Section [005], "System Times"* or can be programmed to sound until a valid code is entered, *Section [014], "Second System Option Code, option [8]"*.
If a Fire zone is violated it will be displayed on all keypads. Typically this zone is used for pull stations.
- [09] For Future Use**
- [10] 24 Hour Supervisory Buzzer Zone**
Whether armed or disarmed, when this zone type is violated the panel will immediately latch the keypad buzzer until a valid user code is entered and will communicate immediately to the central station.
- [11] 24 Hour Burglary Zone**
If this zone is violated, whether armed or disarmed, the panel will immediately latch the alarm output and communicate to the central station. The alarm will sound for the Bell Cutoff time programmed in *Section [005] "System Times"* or until a valid user code is entered.
- [12]-[20]** The following zone definitions operate similar to the 24 Hour Burglary except for System Event output type and SIA identifier:

[12] 24 Hour Holdup Zone	[15] 24 Hour Medical Zone	[18] 24 Hour Sprinkler Zone
[13] 24 Hour Gas Zone	[16] 24 Hour Panic Zone	[19] 24 Hour Water Flow Zone
[14] 24 Hour Heat Zone	[17] 24 Hour Emergency Zone	[20] 24 Hour Freezer Zone
- [21] 24 Hour Latching Tamper**
If this zone is violated the installer must enter Installer Programming before the panel will allow either Partition to be armed.
- [22] Momentary Keyswitch Arm Zone**
Momentary violation of this zone will alternately arm/disarm the Partition the zone is assigned to. This zone type should not be programmed as global.
- [23] Maintained Keyswitch Arm Zone**
When this zone is violated the Partition it is assigned to will disarm. When this zone is secured the Partition it is assigned to will arm. This zone type should not be programmed as global.

5.2 Zone Attributes

Each zone will operate according to the Zone Definition selected for it (*See Section 5.1 "Zone Definitions"*). Additional zone attributes can be programmed to customize the operation of a zone for a specific application. The following attributes are programmable by zone:

Attributes for Fire Zones should not be changed from default.

Audible/Silent

Determines whether the zone will activate the alarm output or will be silent.

Pulsed/Steady

Determines if the alarm output will be steady or pulse on for 1 second and off for one second.

Activate Chime

Determines if the zone will activate the chime feature (*See Section 3.4 "[*] Commands, [*] [4] Doorchime ON/OFF"*).

Bypass Enable

Determines if the zone can be manually bypassed (*See Section 3.4 "[*] Commands, [*] [1] - Zone Bypass"*).

Force Arm Enable

Determines if the system can be armed with the zone violated. At the end of exit delay, if this type of zone is violated, it will be ignored by the panel. Once the zone is secured it will be added back into the system. This zone attribute is useful for a garage door. The customer can arm the system with the garage door open. Later when the customer closes the door it becomes part of the system.

Swinger Shutdown Enable

Determines if the panel will shut down the communicator for the zone after the swinger limit is reached (*See Section 5.17 "Swinger Shutdown"*).

Transmission (TX) Delay Enable

Determines if the panel will delay communicating the alarm reporting code to the central station (*See Section 5.18 "Transmission Delay"*).

.....

Zones 1 to 32 Attributes	Section [101] - [132]
Audible/Silent Alarm	Section [101] - [132], Option [1]
Pulsed/Steady Alarm	Section [101] - [132], Option [2]
Activate Chime	Section [101] - [132], Option [3]
Bypass Enable	Section [101] - [132], Option [4]
Force Arm Enable	Section [101] - [132], Option [5]
Swinger Shutdown Enable	Section [101] - [132], Option [6]
Transmission Delay Enable	Section [101] - [132], Option [7]

.....

5.3 Communicator - Dialing

If the **Communicator Disable** option is selected the panel will not attempt to call central station. If enabled the panel will attempt to call central station when an event occurs that has a valid reporting code programmed (See Section 5.7 "Communicator - Reporting Code").

Communicator Call Direction Options are used to select which phone number the panel will dial when an event occurs. A phone number must also be programmed for the panel to attempt to dial.

If **DTMF Dialing** is enabled the panel will dial using DTMF (touch tone). If **Switch to Pulse Dial** is enabled the panel will switch to pulse dialing on the fourth attempt to call the central station. If disabled the panel will always dial DTMF.

If **DTMF Dialing** is disabled the panel will always pulse dial.

The **Post Dial Wait for Handshake** determines the amount of time the panel will wait for a valid handshake from the receiver. If the panel does not hear the handshake it will consider the call a failed attempt, hang up and try again.

The **Maximum Dialing Attempts** determines the maximum number of attempts the panel will make to send a signal to the central station before indicating a Failure to Communicate (FTC) trouble condition. The 3rd Phone Number can be used to back up the 1st in this situation (See Section 5.4 "Communicator - Phone Numbers").

.....

Pulse Dialing	Section [380], Option [3]
Switch to Pulse Dial	Section [380], Option [4]
Post Dial Wait for Handshake	Section [161]
Maximum Dialing Attempts	Section [160]
Communicator Disable	Section [380], Option [1]
Communicator Call Direction Options	Section [361] to [368]

.....

5.4 Communicator - Phone Numbers

The panel can call 3 different phone numbers for communication to central station. The **1st Phone Number** is the primary number, the **2nd Phone Number** is the secondary number and the **3rd Phone Number** will back up the 1st phone number if enabled.

! *The 3rd Phone Number will NOT back up the 2nd Phone Number.*

If **Alternate Dial** is enabled the panel will alternate between the 1st and 3rd phone numbers when attempting to call the central station. If disabled the panel will only attempt to call the 3rd phone number after failing to communicate on the 1st phone number.

! *For Alternate Dial to work properly, the 3rd Phone Number must be enabled and both phone numbers must be programmed.*

Phone numbers can be up to 32 digits which will allow you to add special digits if required. To program the phone number enter numbers 0 through 9 as required. The following is a list of HEX digits which can also be programmed and the function they perform:

- HEX (B) - simulates the [*] key on a touch tone phone
- HEX (C) - simulates the [#] key on a touch tone phone
- HEX (D) - forces the panel to search for dial tone
- HEX (E) - forces the panel to pause for 2 seconds
- HEX (F) - end of phone number marker

.....

1st Phone Number	Section [301]
2nd Phone Number	Section [302]
3rd Phone Number	Section [303]
3rd Phone Number Enable	Section [380], Option [5]
Alternate Dial	Section [380], Option [6]

.....

5.5 Communicator - Account Numbers

There are two **Partition Identifier Codes** (or Account Numbers) programmable, one for each Partition. The Account Number is used by central station to determine which panel is calling.

If the panel is programmed as two Partitions both Account Numbers must be programmed. The panel will report to the central station by Partition. For example, if an alarm occurs on a zone assigned to Partition 1 the panel will report using Partition 1 Account Number.

Program all null digits as zero (0) at the end of each Partition Identifier Code. For example, for "1234," program [123400]; for "24689," program [246890].

-
- Partition 1 Identifier Code Section [310]
- Partition 2 Identifier Code Section [311]
-

5.6 Communicator - Reporting Formats

Each central station phone number of the panel can be programmed to report using any one of the 4 formats available. A 20 BPS pulse format is supported in addition to 200 baud FSK, Contact ID, SIA and a Pager format. The following is a description of each:

5.6.1 Pulse Formats

Depending on the pulse format selected the panel will communicate using the following:

- 3/1, 3/2, 4/1 or 4/2
- 1400 or 2300 Hz handshake
- 20 bits per second
- non-extended

Additional Notes on Pulse Formats

1. The digit '0' will send no pulses and is used as a filler.
2. When programming account numbers enter six digits.
3. When programming a three digit account number, the remaining three digits must be programmed as a plain '0' which will act as a filler digits.
4. If an account number has a '0' in it, substitute a HEX digit 'A' for the '0'.

Examples:

- 3 digit account number [123] - program [123000]
- 4 digit account number [4079] - program [4A7900]
- 3 digit account number [502] - program [5A2000]

5. When programming reporting codes two digits must be entered. If one digit reporting codes are to be used the second digit must be programmed as a '0'. If a '0' is to be transmitted substitute a HEX digit 'A' for the '0'.

Examples:

- 1 digit reporting code [3] - program [30]
- 2 digit reporting code [30] - program [3A]

6. To prevent the panel from reporting an event program the reporting code for the event as [00] or [FF].

-
- Communicator Format Options Section [360]
-

5.6.2 Contact ID

Contact ID is a specialized format that will communicate information quickly using tones rather than pulses. In addition to sending information more quickly the format also allows more information to be sent. For example, rather than reporting an alarm zone 1 the Contact ID format can also report the type of alarm, such as Entry/Exit alarm zone 1.

To program Contact ID a two digit number from Appendix A must be entered for every event to be transmitted. The two digit number determines the type of alarm. The panel will automatically generate all other information, including the zone number.

This communication format cannot be selected if Central Station Two-Way Voice is required.

Additional Notes on Contact ID

1. Account numbers must be four digits in length, followed by '00'.
2. If the digit '0' is in the account number substitute the HEX digit 'A' for the '0'.
3. All reporting codes must be two digits in length.
4. If the digit '0' is in the reporting code substitute the HEX digit 'A' for the '0'.
5. To prevent the panel from reporting an event program the reporting code for the event as [00] or [FF]. Refer to Appendix A for a list of Contact ID Identifiers.

-
- Communicator Format Options Section [360]
-

5.6.3 SIA (Level 2)

SIA is a specialized format that will communicate information quickly using frequency shift keying (FSK) rather than pulses. The SIA format will automatically generate the type of signal being transmitted, such as Burglary, Fire, Panic etc. The two digit reporting code is used to identify the zone or user code number.



If the SIA format is selected the panel can be programmed to automatically generate all zone and user codes numbers eliminating the need to program these items.

If the SIA Sends Automatic Reporting Codes option is enabled the panel will operate as follows:

- 1. If the reporting code for an event is programmed as [00] the panel will not attempt to call the central station.
 - 2. If the reporting code for an event is programmed as anything from [01] to [FF] the panel will AUTOMATICALLY generate the zone or user code number.
 - 3. Bypassed zones will always be identified when partial closing the system.
- The Communicator Call Direction Options can be used to disable reporting of events such as Openings/Closings. Also, if all the Opening/Closing reporting codes were programmed as [00] the panel would not report.

If the SIA Sends Automatic Reporting Codes option is disabled the panel will operate as follows:

- 1. If the reporting code for an event is programmed as [00] or [FF] the panel will not attempt to call central station.
 - 2. If the reporting code for an event is programmed as anything from [01] to [FE] the panel will send the programmed reporting code.
 - 3. Bypassed zones will never be identified, regardless of reporting code for "partial closing".
- Refer to Appendix B for a list of SIA identifiers.

.....

Communicator Format Section [360]
 SIA Sends Automatic Reporting Codes Section [381], Option [3]
 Communicator Call Direction Options Section [361] to [368]
 SIA Identifiers Appendix B

.....

5.6.4 Pager Format

The **Communicator Format** option for either phone number can be programmed for Pager Format. If an event occurs and the **Communicator Call Direction** options direct the call to a phone number with the Pager Format selected the panel will attempt to page.

When calling a pager extra digits will be required to make it work properly.

The following is a list of Hex digits and what function they perform:

- Hex [B] - simulates the [*] key on a touch tone phone
- Hex [C] - simulates the [#] key on a touch tone phone
- Hex [D] - forces the panel to search for dial tone
- Hex [E] - two second pause
- Hex [F] - end of phone number marker

The panel will attempt to call the pager one time. After dialing the digits in the phone number the panel will send the account number and reporting code followed by the [#] key (Hex [C]).

The panel has no way of confirming if the pager was called successfully which means a failure to communicate trouble will never be generated.

.....

Communicator Format Options Section [360]
 Communicator Call Direction Options Section [361] to [368]

.....

5.6.5 200 Baud FSK

200 baud FSK is a specialized format that will communicate information quickly using frequency shift keying (FSK) rather than pulses. A one-digit identifier is transmitted along with a two-digit reporting code which is used to identify the zone, user code number or event.

The 200 baud FSK format uses five-digit reporting codes with the last digit programmed as a zero (0).

The Communicator Call Direction Options can be used to disable reporting of events such as Openings/Closings. Also, if all the Opening/Closing reporting codes were programmed as [00] the panel would not report.

If the 200 baud FSK Open/Close Identifier Toggle is OFF, Closing (Arming) will send an identifier of 1 and Opening (Disarmings) will send an identifier of 2. Similarly, if the 200 baud FSK Open/Close Identifier Toggle is ON, Closings (Arming) will send an identifier of 2 and Opening (Disarmings) will send an identifier of 1.

.....

Communicator Format Options Section [360]
 Communicator Call Direction Options Section [361] to [368]
 200 Baud FSK Open/Close Identifier Toggle ... Section [381], Option 5

.....

5.7 Communicator - Reporting Codes

The panel can be programmed to report events to a central station. The panel will send the reporting code programmed for the event.

Reporting codes can be one or two digits and can use HEX digits (A through F). The following is a description of the different reporting codes that can be programmed and when the events will be reported to central station.

5.7.1 Zone Alarm

The panel will transmit the **Zone Alarm** Reporting Code for a zone when the zone goes into alarm. 24 hour type zones will go into alarm whether the panel is armed or disarmed and report to the central station. All other zone types will only go into alarm if the panel is armed.

5.7.2 Zone Restoral

If the **Restoral on Bell Timeout** option is selected the panel will send the **Zone Restoral** Reporting Code for the zone when the alarm output times out AND the zone is secure. If the zone is not secured when the alarm output times out the panel will send the restoral immediately after the zone is secured.

If the **Restoral on Bell Timeout** option is not selected the panel will immediately send the **Zone Restoral** Reporting Code when the zone is secured or when the panel is disarmed, regardless if the alarm output is active or not.



24 Hour type zones will report the restoral immediately after the zone is secured.

5.7.3 Closings

The panel will transmit a **Closing** Reporting Code to indicate a Partition(s) is armed. A different reporting code can be transmitted for each User Code, Partition Master Code and System Master Code to identify who armed the Partition(s).

A **Partial Closing** Reporting Code will be transmitted if a Partition is armed with zones manually bypassed. The code will also be transmitted if a Partition Auto Arms with zone(s) in violation.

A **Special Closing** Reporting Code will be transmitted if the Partition(s) is armed using any of the following methods:

- Quick Arm
- Auto Arm
- Arming with the Maintenance Code
- Arming via the DLS Software
- Arming via keyswitch
- “Away” Function Key arming
- “Stay” Function Key arming
- “Global” function key arming

A **Closing by Duress Code** Reporting Code will be transmitted in addition to the Duress reporting code if a Partition(s) is armed using a Duress Code.

A **Recent Closing** Reporting Code will be transmitted if an alarm occurs within 2 minutes of the exit delay expiring.

5.7.4 Openings

The panel will transmit an **Opening** Reporting Code to indicate a Partition(s) has been disarmed. A different reporting code can be transmitted for each User Code, Partition Master Code and System Master Code to identify who disarmed the Partition(s).

A **Special Opening** Reporting Code will be transmitted if the Partition(s) is disarmed using any of the following methods:

- Disarming using the Maintenance Code
- Disarming via the DLS Software
- Disarming via keyswitch

An **Opening After Alarm** Reporting Code will be transmitted in addition to the opening when the Partition(s) is disarmed after an alarm has occurred.

An **Opening by Duress** Reporting Code will be transmitted in addition to the Duress reporting code if a Partition(s) is disarmed using a Duress Code.

5.7.5 Tamper

If the panel is programmed for double EOL zones (See Section 2.9 “Zone Wiring”), the panel will report a **Zone Tamper Alarm** Reporting Code if an open condition is present on a zone. A different reporting code can be programmed for each zone for identification. The **Zone Tamper Restoral** Reporting Code will be transmitted immediately when the tamper condition is restored.

A **General System Tamper** Reporting Code will be transmitted when the tamper zone on any module is violated. The **General System Tamper Restoral** Reporting Code will be transmitted when the tamper zone on the module is restored.

5.7.6 Priority/Emergency

The panel will transmit a **Keypad Fire Alarm** Reporting Code AND the **Keypad Fire Restoral** Reporting Code when the Fire Keys on any keypad is pressed for two seconds.

The panel will transmit a **Keypad Auxiliary Alarm** Reporting Code AND the **Keypad Auxiliary Restoral** Reporting Code when the Auxiliary Keys on any keypad is pressed for two seconds.

The panel will transmit a **Keypad Panic Alarm** Reporting Code AND the **Keypad Panic Restoral** Reporting Code when the Panic Keys on any keypad is pressed for two seconds.

The panel will transmit a **Duress** Reporting Code any time either Duress Code is entered at any keypad. If the panel is armed using the Duress Code the panel will also transmit a **Closing by Duress** Reporting Code or if the panel is disarmed it will also transmit an **Opening by Duress** Reporting Code.

5.7.7 Maintenance

The panel will transmit a **Battery Trouble Alarm** Reporting Code when the backup battery drops below 11.5 Vdc. The **Battery Trouble Restoral** Reporting Code will not be transmitted until the battery has been charged over 12.5 Vdc.

To prevent the panel from transmitting an **AC Failure Trouble Alarm** Reporting Code during short power outages the panel will not send the signal unless AC power is lost for the amount of minutes programmed for the AC Failure Communication Delay. The **AC Failure Trouble Restoral** Reporting Code will be transmitted as soon as AC power is restored.

A **Bell Circuit Trouble Alarm** Reporting Code will be transmitted immediately if an open condition is measured on the Bell Output of the main panel. The **Bell Circuit Trouble Restoral** Reporting Code will be transmitted as soon as the problem is corrected.

A **Fire Trouble Alarm** Reporting Code will be transmitted immediately when an open condition is measured on any Fire type zone (See Section 5.1 "Zone Definitions"). The **Fire Trouble Restoral** Reporting Code will be transmitted as soon as the problem is corrected.

The **Auxiliary Power Supply Trouble Alarm** Reporting Code will be transmitted if the AUX output is shorted. The AUX output control incorporates a fuseless design. When excessive current is drawn the panel will automatically shut off the output. The panel will constantly check the AUX output and when the excessive current draw is removed the panel will reset the output and transmit an **Auxiliary Power Supply Trouble Restoral** Reporting Code.

The **TLM Restoral** Reporting Code will be transmitted within 10 seconds of a telephone line monitoring problem being corrected.

A **General System Trouble** Reporting Code will be transmitted if the panel detects any of the following on the PC5204 Power Supply/Output Module: AC Power Failure, Low Battery, AUX Output Trouble, Output #1 Supervisory trouble or the PC5400 is off-line. The **General System Trouble Restoral** Reporting Code will be transmitted when all of the listed problems are corrected.

A **General System Supervisory Trouble** Reporting Code will be transmitted if any module goes missing from the Keybus. If the module is a zone expander the panel will also transmit the **Zone Expander Supervisory Alarm Trouble** Reporting Code. The panel will send a **General System Supervisory Restoral** Reporting Code when the problem is corrected as well as a **Zone Expander Supervisory Restoral** Reporting Code if the module is a zone expander.

5.7.8 Test Transmissions

The panel can be programmed to transmit a **Periodic Test Transmission** Reporting Code (See Section 5.13 "Test Transmissions") or a **System Test** Reporting Code (See Section 3.4 "[*] Commands, [*] [6]").

5.7.9 Miscellaneous

The panel will transmit the **Keypad Lockout** Reporting Code if the lockout is activated (See Section 5.22 "Keypad Lockout").

The **DLS Lead In** Reporting Code will only be transmitted if the **DLS Call Back** feature is being used (See Section 5.8 "Downloading"). Before the panel calls the computer back it will call central station and transmit the reporting code to indicate a download session is about to begin. After downloading is complete the panel will transmit a **DLS Lead Out** Reporting Code to indicate the download session is complete.

If the panel fails to transmit information to the central station it will display a failure to communicate trouble condition. The panel will transmit a **Phone Number 1 Failure to Communicate** Reporting Code or a **Phone Number 2 Failure to Communicate** Reporting Code the next time it calls the central station. The panel will transmit the old events, followed by the failure to communicate, followed by the new events. This will allow central station to determine which events are old or new.

If the Event Buffer is uploaded on a regular basis an **Event Buffer 75% Full** Reporting Code can be transmitted to warn the Buffer is almost full. This is also useful if the PC5400 Printer Module is being used.

.....
Reporting Codes..... Section [320] to [353]
.....

5.8 Downloading

Downloading allows programming of the entire control panel via a computer, modem and telephone line. All functions and features, changes and status, such as trouble conditions and open zones can be viewed or programmed by downloading.

! *When power is applied to the panel downloading will be enabled for 6 hours. This will allow you to perform downloading without having to do any keypad programming.*

If the **Downloading Answer** option is enabled (or during the first 6 hours after power up) the panel will answer incoming calls for downloading provided the following conditions occur:

1. The panel hears one or two rings then misses a ring.
2. At this point the panel will start a timer.
3. If the panel hears another ring before the **Answering Machine Double Call Timer** expires it will answer on the first ring of the second call.

The panel will immediately go on line and begin the download process unless the **Call Back** option is enabled. If enabled, the panel and computer will both hang up. The panel will then call the **Download Computer Telephone Number** and wait for the computer to answer. Once the computer answers downloading will begin.

If **User Enable DLS Window** is enabled the user can turn the downloading feature on for 6 hours through the [*][6] keypad command. After 6 hours the panel will not answer incoming calls unless Downloading Answer is enabled (See Section 3.4 "[*] Commands, [*][6] User Functions").

The **Download Access Code** and **Panel Identifier Code** are for security and proper identification. Both the panel and the computer file should have the same information programmed before attempting to download.

! *For more information refer to the Download Manual included with the computer software.*

.....

Downloading Answer	Section [401], Option [1]
User Enable DLS Window	Section [401], Option [2]
Call Back	Section [401], Option [3]
Answering Machine Double Call Timer	Section [405]
Download Computer Telephone Number	Section [402]
Download Access Code	Section [403]
Panel Identifier	Section [404]

.....

5.9 Partitions/Zone Assignment

A partition is a defined area which will operate independent of another area of the system. The panel can be divided into two partitions. For example, in an office/warehouse installation it may be necessary to limit warehouse employees from accessing the office and office employees from accessing the warehouse.

Any zone can be assigned to either, or both partitions. Any Access Code can be assigned to work on either, or both partitions (See Section 3.4 "[*] Commands, [*][5] Programming Access Codes").

Common Zones are zones assigned to both partitions. A common zone will only be armed when both partitions are armed and will be disarmed when either partition is disarmed.

Keypads can be assigned to work on either partition or can be assigned for Global operation (See Section 2.6 "Keypad Assignment").

Each partition can be programmed to report using a different Account Number (See Section 5.5 "Communicator - Account Numbers").

Some of the Programmable Output options are also selectable by Partition (See Section 5.10 "PGM Outputs").

The **Partition 2 Enable** option must be programmed before Partition 2 will operate.

At default zones 1 through 8 are assigned to Partition 1. If additional zones are being used or the application requires two Partitions zones must be enabled to operate on the correct Partition.

! *Zones programmed as Null must be removed from both Partitions (See Section 5.1 "Zone Definition).*

.....

Partition 2 is Enabled	Section [201], Option [1]
Partition 1 Zone Assignments	Section [202] to [205]
Partition 2 Zone Assignments	Section [206] to [209]

.....

5.10 PGM Outputs

There are 3 different types of Programmable Outputs available. They are listed as follows:

- PGM1 and PGM2 on the main board
- 8 low current outputs available with the PC5208 Output Module
- 4 high current outputs available with the PC5204 Power Supply/Output Module

Programming any of the PGM Outputs is a two step process. First an option from the below list must be selected for the PGM Output. Second the PGM Attributes must be selected. The following is a list of the PGM Output Options and PGM Attributes.

5.10.1 PGM Output Options

[01] Burglary and Fire Bell Output

The PGM output will activate when the alarm output is active and will turn off when the alarm output is silenced. If the alarm output is pulsing the PGM output will pulse as well. This output does not follow the pre-alert for delayed fire zones.

[02] Utility Output

The PGM output will activate for 5 seconds when the [*][7][1][Access Code] command is entered (See Section 3.0 "Keypad Commands").

[03] Sensor Reset

This option is used to reset power for latching smoke detectors.



The output will normally be active, switched to ground.

The output will deactivate for 5 seconds when the [*][7][2] command is entered (See Section 3.0 "Keypad Commands"). The keypad buzzer will not sound for the 5 second period.

Refer to the hookup diagram in this manual for wiring instructions.

[04] For Future Use

[05] Partition/System Armed Status

The PGM output will activate when the Partition or System is armed and deactivate when disarmed.

[06] Ready Output

The PGM output will activate when the Partition or System is ready to arm. The output will deactivate when the system is not secure or upon arming.

[07] Keypad Buzzer Follow

The PGM will activate when any of the following events occur and will remain active for as long as the keypad buzzer is active:

- Doorchime
- Entry Delay
- Audible Exit Delay
- Auto-Arm Prealert
- 24 Hour Supervisory Buzzer Zone

[08] Courtesy Pulse

Upon arming the PGM output will activate for the duration of the exit delay plus two minutes. Upon entry the PGM output will activate for the duration of the entry delay plus two minutes. Only one courtesy pulse output may be programmed on a system.

[09] System Trouble

The PGM output will activate when any of the selected trouble conditions are present. It will deactivate when all the selected trouble conditions are cleared.

The normal PGM attributes, programmed in Sections [141] to [154] is replaced with the following list for any output selected as System Trouble:

- Light [1] Service Required (battery, bell, general trouble, general tamper, general supervisory)
- Light [2] AC Failure
- Light [3] Telephone Line Trouble
- Light [4] Failure to Communicate
- Light [5] Fire Trouble / Zone Fault
- Light [6] Zone Tamper
- Light [7] Zone Low Battery
- Light [8] Loss of Clock

[10] Latched System Event

The PGM output will activate when any of the selected events occur. It will deactivate when an access code is entered. Global alarms must be silenced with a global code.

The normal PGM attributes, programmed in Sections [141] to [154] is replaced with the following list for any output selected as Latched System Event:

- Light [1] Burglary Delay, Instant, Interior, Stay/Away and 24 Hour Burglary Zones
- Light [2] Fire Fire Keys, Fire Zone (PGM Output)
- Light [3] Holdup Holdup zones and Duress alarms
- Light [4] Medical Auxiliary Keys, Medical and Emergency Zones
- Light [5] Supervisory ... Supervisory, Freezer and Water Zones
- Light [6] Priority Gas, Heat, Sprinkler and 24 Hour Latching Zones
- Light [7] Partition 1 PGM enable] *Either or both of these lights should be ON to indicate*
- Light [8] Partition 2 PGM enable] *which Partition(s) will activate the PGM output.*

[11] System Tamper

The PGM Output will activate when any Tamper condition is present and will deactivate when all Tamper conditions are cleared.

[12] TLM and Alarm

The PGM Output will activate when a telephone line fault condition is present AND an alarm occurs. The PGM Output will remain active until an access code is entered. The output will activate for both audible and silent alarms if a TLM trouble is present.



This output will activate for all audible and silent alarms except Duress.

[13] Kissoff

The PGM Output will activate for two seconds after the panel receives the kissoff from the central station.

[14] Ground Start

The PGM Output will activate for two seconds before the panel attempts to dial to obtain dial tone on Ground Start telephone equipment. Two 2-second pauses should be inserted at the beginning of the phone number when using this option.

-
- Main Board PGM Outputs Section [009]
- PC5208 PGM Output Options Section [010]
- PC5204 PGM Output Options Section [011]
-

5.10.2 PGM Output Attributes

Each Programmable Output also requires the PGM Attributes to be programmed before they will operate correctly. Attributes available are as follows:

PGM Options 2, 3, 5-7

- Option [1] - ON Partition 1 Controls Event
 OFF Partition 1 Does Not
- Option [2] - ON Partition 2 Controls Event
 OFF Partition 2 Does Not
- Option [3] - ON Output Activates on Event
 OFF Output Deactivates on Event

PGM Options 1, 8, 11-16

- Option [1] - Must be ON
- Option [3] - ON Output Activates on Event
 OFF Output Deactivates on Event



The Attribute Options for Option [09] System Trouble and [10] Latched System Event are different. Refer to these options for more information.

-
- PGM1 (Main Board) Output Attributes Section [141]
- PGM2 (Main Board) Output Attributes Section [142]
- PC5208 PGM Output Attributes Section [143] to [150]
- PC5204 PGM Output Attributes Section [151] to [154]
-

5.11 Telephone Line Monitor (TLM)

The panel will supervise the presence of the phone line and indicate a trouble condition if disconnected. If **TLM Enabled** is selected the panel will wait the **TLM Trouble Delay** time before indicating the trouble so that a momentary interruption of the phone line will not cause a trouble condition.

The **TLM Trouble Only** or **Audible When Armed** option will allow you to select if the panel will indicate a trouble condition at the keypad or indicate a trouble at the keypad when disarmed and activate the alarm output when armed.

When the trouble condition is restored the panel can send a **TLM Restoral Reporting Code**. Any events that occurred while the phone line was down will also be communicated.

.....

TLM Enable/Disable	Section [015], Option [7]
TLM Trouble Only or Audible When Armed ...	Section [015], Option [8]
TLM Trouble Delay	Section [370]
TLM Restoral Reporting Code	Section [350]

.....

5.12 Siren Supervision

The panel supervises the Bell output. If an open condition is detected or the fuse is blown the panel will immediately indicate a trouble condition and beep the keypad twice every ten seconds to alert the owner of the problem. The panel can send a **Bell Circuit Trouble** Reporting Code immediately. Once the problem is corrected the panel can send a **Bell Circuit Trouble Restoral** Reporting Code.

.....

Bell Circuit Trouble Reporting Code	Section [349]
Bell Circuit Trouble Restoral Reporting Code	Section [350]

.....

5.13 Test Transmission

To ensure the communication link with the central station is functioning properly the panel can be programmed to send a test transmission signal.

The panel can send a **Periodic Test Transmission Reporting Code** at the programmed **Test Transmission Time of Day**. By default, the **Test Transmission Cycle** determines the number of days (001 to 255) between tests. If the test transmission is being programmed with a new value lower than the original, the system will wait the original period before the next test transmission is sent, and then begin reporting with the new interval. If the **Test Transmission Counter in Hours** option is enabled, the test transmission cycle will be in hours. If the **Test Transmission while armed only** is selected, test transmissions will only occur when the panel is armed.

The end user can generate a communicator test. If the **System Test Reporting Code** is programmed the panel will send the signal= when the System Test keypad command is entered (See Section 3.4 "[*] Commands, [*][6] User Functions").

.....

Periodic Test Transmission Reporting Code	Section [352]
Test Transmission Time of Day	Section [371]
Test Transmission Cycle	Section [370]
System Test Reporting Code	Section [352]
Test Transmission Counter in Hours	Section [701], Option [7]
Test Transmission while armed only	Section [381], Option [6]

.....

5.14 Fire, Auxiliary, Panic Keys

The emergency keys are available on all keypads. These keys must be pressed and held for 2 seconds before they will activate. This 2 second delay is designed to help prevent accidental activation.

If the **Fire Keys** option is enabled, when the Fire keys are pressed and held for 2 seconds, the panel will activate the alarm output, pulsing one second on, one second off. If **Fire Bell Continuous** is selected the alarm output will sound until a code is entered, otherwise it will sound until a code is entered or the alarm output times out. Communication of the signal to central station is immediate.

If the **Auxiliary Keys** are pressed and held for 2 seconds the panel will sound the keypad beeper three times to verify activation. The panel will beep the keypad ten times rapidly to verify communication to the central station.

If the **Panic Keys** are pressed and held for 2 seconds, the panel will immediately communicate the signal to central station. If **Panic Keys Audible** is enabled, the panel will beep the keypad three times upon activation and activate the alarm output until a code is entered or the alarm output times out. Otherwise the alarm will be completely silent.

! *The Fire, Auxiliary, Panic keys will operate even if Keypad Blanking is active (See Section 5.23 "Keypad Blanking").*

.....

Fire Keys Enable	Section [015], Option [1]
Panic Keys Audible	Section [015], Option [2]
Fire Bell Continuous	Section [014], Option [8]

.....

5.15 Entry/Exit Delay Options

Upon arming, the panel will begin the exit delay. If **Audible Exit Delay** is enabled the keypad will beep every second until the exit delay expires. The keypad will beep rapidly for the last 10 seconds of exit delay to warn the user the system is about to arm.

For commercial applications **Bell Squawk on Exit Delay** may be enabled. The panel will squawk the alarm output once every second when the exit delay is initiated and 3 times a second for the last 10 seconds until the exit delay expires.

Upon entry, if a Delay type zone is violated, the panel will begin entry delay. The keypad will emit a steady tone. The keypad will pulse the keypad sounder during the last 10 seconds to warn the user the system is about to go into alarm. If there was an alarm during the armed period, the keypad sounder will pulse for the entire entry delay to warn the user of the previous alarm.

For commercial applications **Bell Squawk on Entry Delay** may be enabled. The panel will squawk the alarm output once every second until the entry delay expires or the system is disarmed. This feature must not be used with 2 partitions.

! *Since two Delay zones are programmable, and therefore two different Entry Delays, when the panel is armed it will use the Entry Delay for the first Delay zone violated.*

If **Exit Delay Termination** is enabled the panel will monitor the Delay zones during exit delay. If a Delay type zone is violated then secured during the exit delay, the exit delay will be terminated and the panel will be armed immediately.

To prevent false alarms upon exiting PC5016, use the built-in **Audible Exit Fault** feature. If a delay type zone is violated within four seconds after the exit delay has expired, the panel will sound the entry delay warning through the keypad and siren alerting the customer that an improper exit was made. If the panel is disarmed within the entry delay no signal is sent. If not, the panel will continue to sound the alarm and send a signal to central station.

.....

Audible Exit Delay	Section [014], Option [6]
Bell Squawk on Exit Delay	Section [014], Option [3]
Exit Delay Termination	Section [014], Option [7]
Bell Squawk on Entry Delay	Section [014], Option [4]

.....

5.16 Event Buffer

The panel will store the last 256 events that have occurred on the system. Each event will contain the time, date, partition and the event itself along with the zone number, user code number or any other information pertaining to the event.

If the **Event Buffer Follows Swinger Shutdown** feature is enabled the event buffer will not store events after the swinger shutdown level has been reached. This will prevent the panel from overwriting the entire buffer if a problem exists. (See Section 5.17 "Swinger Shutdown".)

The event buffer can be viewed three different ways. It can be viewed through an LCD keypad, printed on-site using the PC5400 printer module (See Section 5.27 "On-Site Printer") or it can be uploaded through the DLS software.

5.16.1 Viewing the Event Buffer through the LCD Keypad

The following is the procedure for viewing the event buffer through the LCD keypad:

Step 1 - Enter [*] [6] [Master Code]

Step 2 - Select 'View Event Buffer'

The keypad will display the Event Number, Partition, Time and Date of the event in question. Use the [*] key to toggle between this information and the event itself. Use the arrow keys (<>) to scroll through the events in the buffer.

When you have finished viewing the event buffer press the [#] key to exit.

.....

Event Buffer Follows Swinger Shutdown	Section [013], Option [7]
---	---------------------------

.....

5.17 Swinger Shutdown

The swinger shutdown feature is designed to prevent a runaway communicator from tying up the central station. Different limits can be programmed for **Zone Alarms**, **Zone Tamper**s and **Maintenance** signals. After the panel has communicated the programmed number of transmissions for an event it will no longer report that event until the swinger shutdown is reset.

For example, the swinger shutdown limit for Zone Alarms is set to [003]. The panel will not send more than 3 alarm signals for each zone with a swinger attribute until the swinger shutdown is reset.

Swinger Shutdown will be reset when the panel is armed or every day at midnight. Once reset, the panel will again communicate normally.

.....

Swinger Shutdown Limit (Alarms)	Section [370]
Swinger Shutdown Limit (Tamper)s	Section [370]
Swinger Shutdown Limit (Maintenance)	Section [370]

.....

5.18 Transmission Delay

If **Transmission Delay** is selected for a zone the panel will delay reporting the alarm for the number of seconds programmed for **Transmission Delay Time**. If the panel is disarmed before the delay time expires the panel will not report the alarm to central station. If the panel is not disarmed in time the panel will communicate normally.

 *This is a global feature.*

.....

Transmission Delay Enable	Sections [101] to [132], Option [7]
Transmission Delay Time	Section [370]

.....

5.19 Keypad Backlighting

The keys of all the keypads can be backlit to provide easy viewing in dim lighting conditions. If the **Keypad Backlighting Option** is enabled the keys will be illuminated.

.....

Keypad Backlighting Option	Section [016], Option [5]
----------------------------------	---------------------------

.....

5.20 Arming/Disarming Options

If the **Arm/Disarm Bell Squawk** option is enabled the panel will squawk the alarm output once upon arming and twice upon disarming. The **Opening After Alarm Keypad Ringback** option will give you the ability to beep the keypad 10 times rapidly if the panel is disarmed after an alarm occurred. The **Opening After Alarm Bell Squawk** option will give you the ability to squawk the bell output 10 times rapidly if the panel is disarmed after an alarm occurred.

Closing Confirmation, if enabled, will cause the keypad to beep 10 times rapidly after the closing reporting code has been transmitted to central station.

.....

Arm/Disarm Bell Squawk	Section [014], Option [1]
Opening After Alarm Keypad Ringback	Section [381], Option [1]
Opening After Alarm Bell Ringback	Section [381], Option [2]
Closing Confirmation	Section [381], Option [4]

.....

5.21 Automatic Arming

There are two different Auto-Arming methods available. Each Partition can be programmed to Auto-Arm at a specific time every day if it is in the disarmed condition. Also a Partition can also be programmed to Auto-Arm if no activity is registered for a programmed number of minutes.

Before the Auto-Arm at a specific time function will work correctly the present **Time of Day** must be programmed.

When the internal panel clock matches the **Auto-Arm Time** the panel will check the status of the Partition. If armed, the panel will do nothing until the next day at the **Auto-Arm Time**, when it will check again.

If disarmed the panel will sound the buzzer of all keypads assigned to the partition for one minute. If a valid User Code is entered the Auto-Arm will be aborted. The panel will also transmit an **Auto-Arm Abort Reporting Code** if programmed.

If no code is entered the panel will Auto-Arm. If a zone is violated the panel will transmit a **Partial Closing Reporting Code** if programmed to indicate the system was not secure. If the zone is restored the panel will add the zone back into the system.

If the **No Activity Arm** option for a partition is programmed with a number other than 000, the partition will Auto-Arm if no activity is detected for the programmed number of minutes.

The timer will begin when a delay type zone assigned to the partition is secured. The timer is stopped if any zone assigned to the partition is tripped. The timer will restart when a delay type zone is again restored.

When the timer expires the panel will sound the buzzer of all keypads assigned to the Partition for one minute. If any key is pressed, the Auto-Arm will be aborted.

! Zones assigned to both Partitions (Global Zones) will not stop the timer.

Time Date 3.4 [*] Commands, [*][6][1] Time and Date
Auto-Arm Time 3.4 [*] Commands, [*][6][3] Auto-Arm Time
Auto-Arm Cancel Reporting Code Section [348]
Partial Closing Reporting Code Section [343]
No Activity Arm (Partition 1) Section [162]
No Activity Arm (Partition 2) Section [163]

5.22 Keypad Lockout

The panel can be programmed to 'lockout' keypads if a number of incorrect user code entries are made. After the **Number of Invalid Codes Before Lockout** has been reached the panel will lock out the keypad for the **Lockout Duration** and log the event to the event buffer. For the duration of the lockout the panel will sound an error tone when any key is pressed.

! Keypad Lockout will reset every hour.

To disable Keypad Lockout program the **Number of Invalid Codes Before Lockout** as [000].

Number of Invalid Codes Before Lockout Section [012]
Lockout Duration Section [012]
Keypad Lockout Reporting Code Section [338]

5.23 Keypad Blanking

If the **Keypad Blanking Option** is enabled the panel will turn off all lights on the keypads except the backlighting of the keys if no key is pressed for 30 seconds.

The panel will turn the lights back on if entry delay begins or an audible alarm occurs. The lights will also come on if a key is pressed or, if the **Code Required to Restore Blanking Option** is enabled, a valid User Code is entered.

If the **Power Save Option** is enabled the panel will blank all keypad lights including backlighting when AC power fails, in order to conserve the back up battery.

Keypad Blanking Option Section [016], Option [3]
Code Required to Restore Blanking Section [016], Option [4]
Power Save Option Section [016], Option [6]

5.24 Loop Response

The normal loop response time for all zones is 500 milliseconds. The panel will not consider a zone violated unless it is violated for at least 500 milliseconds.

If **Zone 8 is Fast Loop Response** is enabled the loop response for zone 8 will be 40 milliseconds. Typically this can be used for vibration type sensors.

Zone 8 is Fast Loop Response Section [013], Option [5]

5.25 Keypad Tamper

If the **Keypad Tamper Enable** option is selected the panel will display and transmit a **General System Tamper** reporting code if any keypad is removed from the wall. When the keypad tamper is restored the panel will transmit the **General System Tamper Restoral** reporting code. All keypads should be properly installed and secured before enabling this option.

.....

Keypad Tamper Enable Section [016], Option [8]
 General System Tamper Reporting Code Section [338]
 General System Tamper Restoral Reporting Code... Section [338]

.....

5.26 Escort5580 Module

Many consumers will often purchase wants before needs. The alarm system is an identifiable need however rarely is it an item someone wants. The Escort5580 module will help you change the way in which they feel about security.

There are many benefits when adding the Escort5580 module to a security system. The Escort5580 module will turn any touch tone phone in the world into a fully functional keypad. Imagine the security a customer would feel if they had the ability to arm, disarm and check status of the alarm while at the office or on vacation.

In addition, all touch tone phones in the home also become fully functional keypads. This may help reduce the cost of the overall installation because additional keypads (and labour in running wires) can be eliminated.

The Escort5580 will also act as a tutor for the system. By speaking in clear, easy to understand sentences it helps guide a user through functions they may otherwise have difficulty with. Programmable zone labels (up to 6 words each from our library of over 240 words) makes the system even easier to use.

The module also has a built-in power line control interface and can control up to 32 power line control devices for lighting and temperature control, giving you the power to add home automation in a very cost effective manner. Devices can be activated individually, as a group, by schedule or can be activated when an event occurs on the system, such as an alarm.

Additional information can be found in the Escort5580 Installation Manual.

5.27 On-Site Printer

The panel, with the addition of the PC5400 printer module, will print all events as they occur to a local, on-site serial printer. All events printed will include the time, date, partition and the event.

If a problem develops with the printer, such as power loss or paper outage the panel will store events until the problem is corrected, at which point it will print the events from the buffer. The panel can store up to 128 events if such a condition occurs.

.....

PC5400 Programming Section [801]

.....

5.28 Audio Interface Module

The PC5928 Audio Interface will allow you to connect up to 7 Interior (PC5921) or exterior (PC5921EXT) Intercom Stations. These attractive, surface mount stations contain both speaker and microphone and will allow you to add intercom features to your alarm system such as:

- Page/Answer
- Do Not Disturb
- Baby Listener Broadcast
- Answer Incoming Calls
- Doorbell Function
- Background Music

In addition to these features the module also has built-in two-way voice for central station monitoring. The central station can select the audio station, listen/talk, extend on-line time and hang up. For more information regarding the PC5928 Audio Interface Module refer to the Installation Manual for the product.

.....

PC5928 Programming Section [802]

.....

5.29 Default (Factory)

On occasion it may be necessary to default the main control panel or one of the modules that can be connected. There are several different defaults available including defaulting the main control panel, Escort5580 module and PC5400 Printer module.

Note: Defaulting the main panel does not default the keypads. Please refer to “Programming LCD5500 Keypads” in the Programming Worksheets for defaulting the LCD5500. LED55XX keypads must be manually reprogrammed in installers section [000].

5.29.1 Factory Default Main Panel (Hardware)

- Step 1 - Remove AC and battery from the panel.
- Step 2 - Remove all wires from the Zone 1 and PGM1 terminals.
- Step 3 - With a piece of wire short the Zone 1 terminal to the PGM1 terminal.
- Step 4 - Apply AC power to the main panel.
- Step 5 - When Zone Light 1 is lit on the keypad the default is complete.
- Step 6 - Remove AC power from the control
- Step 7 - Reconnect all original wiring and power up the control.

! AC power must be used to power the panel. The panel will not default if the battery is used.

5.29.2 **Factory Default Main Panel (Software) and other Modules**

Step 1 - Enter the Installer Programming mode.

Step 2 - Enter Program Section [XXX].

Step 3 - Enter the Installer Code.

Step 4 - Enter Program Section [XXX] again.

The panel will take a few seconds to perform the default. When the keypad is again operational the default is complete.

.....

Restore Main Panel (Software) to Factory Default Programming Section [999]

Restore Escort5580 to Factory Default Programming Section [995]

Restore PC5400 to Factory Default Programming Section [997]

Restore PC5928 to Factory Default Programming Section [998]

.....

5.30 **Installer Lockout**

If **Installer Lockout** is selected a hardware default cannot be performed. If a software default is performed all programming will restore to factory default.

When **Installer Lockout Disable** is selected the panel will restore all programming to factory defaults if a hardware or software default is performed on the main control panel.

To enable or disable Installer Lockout perform the following:

Step 1 - Enter Installer Programming

Step 2 - Enter Program Section [XXX]

Step 3 - Enter the Installer Code.

Step 4 - Enter Program Section [XXX] again.

.....

Installer Lockout Enable Section [990]

Installer Lockout Disable Section [991]

.....

5.31 **Walk Test (Installer)**

The Installer Walk Test can be used to verify that each zone of the panel is working. To perform a Walk Test, enter the following:

Step 1 - Enter Installer Programming

Step 2 - Enter Section [901]

When any zone is violated the panel will activate the Bell Output for two seconds, log the event to the Event Buffer and communicate the alarm to central station.

To stop the test, you must do the following:

Step 1 - Enter Installer Programming

Step 2 - Enter Section [901]

5.32 **International Programming**

5.32.1 **[700] Automatic Clock Adjust**

In order to compensate for timing inaccuracies, the panel may be programmed to add or subtract seconds during the last minute of each day. Valid entries are 01 - 99. The default setting is 60 seconds. To determine the value to be programmed in this section, monitor the amount of time lost or gained by the panel over a period of time. Then, calculate the average amount of time per day that the panel gains or loses. If the clock's timing is off, it may be corrected with this setting.

Example #1: The clock loses an average of 9 seconds per day.

Solution: Program the panel to adjust the clock by 51 seconds (instead of the default 60 seconds) for the last minute of each day in section [700]. This will speed up the panel's clock by 9 seconds, thus correcting the problem.

Example #2: The clock gains an average of 11 seconds per day.

Solution: Program the panel to adjust the clock by 71 seconds (instead of the default 60 seconds) for the last minute of each day in section [700]. This will slow down the panel's clock by 11 seconds, thus correcting the problem.

5.32.2 **[701] First International Option Code**

1. **Power Line Frequency:** 50Hz/60Hz

2. **Timebase is Internal Crystal:** The timebase is the internal crystal oscillator. In cases of unstable AC power input, the internal crystal can be used to keep the most accurate timebase

Time base is AC line: The timebase is the AC power input. If the 50 or 60Hz AC power input is very stable it can be used as the timebase.

3. **AC/DC Inhibit Arming Enabled:** When this option is enabled and there is an AC or DC trouble present on the system, the Ready Light will be OFF and the system will not be able to be armed. This includes Keypad, Keyswitch, Automatic and Downloading Arming. Arming will not be allowed until the AC or battery trouble is cleared. When there is no trouble present, the system ready light will be on, and the panel will do an automatic battery test of the main panel and modules that support a back-up battery upon entering a valid access code before the panel arms. If the battery is good the panel will arm. If the battery is bad arming will be inhibited. When this option is disabled the panel will not do an automatic battery test upon entering a valid access code and arming will not be inhibited by the presence of an AC or DC trouble.
4. **Latching System Tamper/No Latching System Tamper:** When enabled a system tamper on the system must be reset by entering the Installer's Code [*][8][Installer's Code] before the system can be armed. If there is a system tamper present Auto-Arming and Key switch arming will also be suppressed.



The Auto Arm cancellation code is not transmitted because a User has not cancelled the Auto Arming sequence.

5. **6-Digit User Access Codes:** With this option enabled all of the access codes on the system will become 6-digits in length except the Panel ID code and the Downloading Access Code. If codes are programmed and this option is selected all codes except the System Master Code (#40) and the Installer's code will be erased.
4-Digit User Access Codes: When this option is selected all codes will be 4-Digits in length. If 6-Digits were previously used and this option is enabled the last two digits will be erased.
6. **Busy / Congestion Tone Detection Enabled:** If this is enabled, the panel will hang up the line when it detects a busy or congested tone.
Busy / Congestion Tone Detection Disabled: The panel will not detect a busy or congested tone.
7. **Test Transmission Counter in Hours:** If this option is enabled, the Test Transmission Interval (Section [370]) will be in hours.
Normal Test Transmission: The test transmission counter will be in days (See Section 5.13 "Test Transmission").

5.32.3 [702] Second International Option Code

1. **European Dialing Parameters:** The pulse dialing Make/Break ratio is 33/67.
North American Dialing Parameters: The pulse dialing Make/Break ratio is 40/60.
2. **Force Dialing Enabled:** If the panel fails to call the monitoring station on the first dialing attempt, on every attempt thereafter the panel will dial out with or without the presence of dial tone.
Force Dialing Disabled: The panel will not dial out if dial tone is not detected.
3. **60min Test Transmission:** A test transmission will be sent to the monitoring station every 60 minutes and it will not follow the Test Transmission Interval (Section [370]).
Test Transmission Follows Interval: A test transmission will be sent to the monitoring station at the programmed time of day in Section [371] and at the Interval programmed in Section [370].
4. **1600Hz Handshake:** With this option enabled the communicator will respond to 1600Hz handshakes when using the reporting Communication Formats 1 and 2 only.
Standard Handshake: The communicator will respond to the handshake specified by the BPS format (1400Hz or 2300Hz).
5. **ID Tone Enabled:** With ID Tone Enabled the panel will pulse a tone on the telephone line to indicate that the panel is on the line.
6. **2100Hz/1300Hz:** Selectes the frequency of the ID tone that is pulsed on the line.



Contact your local telephone company to confirm which setting should be used

7. **One-Time One-hour User-enabled DLS Window:** When the User enables the DLS Window through [*][6][Master Code][5] the panel will answer an incoming call for Downloading within the one-hour time Window without having to have Downloading Answer Enabled in Section [401]. After a successful Download has been completed the Window will be closed and a call will not be answered unless Downloading Answer is Enabled.
Full Six-hour User-enabled DLS Window: When the User enables the DLS Window through [*][6][Master Code][5] the panel will answer an incoming call for Downloading within the six-hour window. The window will remain open for the full six hours.
8. **Bell on FTC when Armed:** When enabled, an FTC (Failure to Communicate) on either Partition during the armed period will sound an Audible Alarm for the length of Bell time-out or until the system is disarmed.
FTC Trouble only when Armed: If a Failure to Communicate trouble is generated while the panel is armed only the keypad buzzer will sound trouble beeps every 10 seconds until a key is pressed.

5.32.4 [703] Delay Between Dialing Attempts

For standard (force) dialing the panel will go off-hook, search for dial tone for five seconds, go on-hook for 20 seconds, go off-hook for five seconds then dial. If there is no initial handshake recognized within 40 seconds the panel will then hang up the line. This programmable timer adds delay before the next call is attempted.

Appendix A

C O N T A C T I D

Contact ID

The Partition ID Codes must be 4 digits. All reporting codes must be 2 digits.

The following is a list of Contact ID reporting codes. The first digit (in parentheses) will automatically be sent by the control. The last two digits are programmed to indicate specific information about the signal.

For example, if zone 1 is an entry/exit point, the alarm reporting code could be programmed as [34]. The central station would receive the following:

*BURG - ENTRY/EXIT - 1

In the above example, the "1" indicates which zone went into alarm.



Do not program the following reporting codes: Opening After Alarm, Recent Closing and Event Buffer 75% Full.

This communication format cannot be selected if Central Station Two-Way Voice is required.

Event Codes (as per ADEMCO):

Medical Alarms

- (1)AA Medical
- (1)A1 Pendant Transmitter
- (1)A2 Fail to Report In

Fire Alarms

- (1)1A Fire Alarm
- (1)11 Smoke
- (1)12 Combustion
- (1)13 Water Flow
- (1)14 Heat
- (1)15 Pull Station
- (1)16 Duct
- (1)17 Flame
- (1)18 Near Alarm

Panic Alarms

- (1)2A Panic
- (1)21 Duress
- (1)22 Silent
- (1)23 Audible

Burglar Alarms

- (1)3A Burglary
- (1)31 Perimeter
- (1)32 Interior
- (1)33 24 Hour
- (1)34 Entry / Exit
- (1)35 Day / Night
- (1)36 Outdoor
- (1)37 Tamper
- (1)38 Near Alarm

General Alarms

- (1)4A General Alarm
- (1)43 Exp. module failure
- (1)44 Sensor tamper
- (1)45 Module Tamper

24 Hour Non-Burglary

- (1)5A 24 Hour non-Burg
- (1)51 Gas detected
- (1)52 Refrigeration
- (1)53 Loss of Heat
- (1)54 Water Leakage
- (1)55 Foil Break
- (1)56 Day Trouble
- (1)57 Low bottled Gas level
- (1)58 High Temp
- (1)59 Low Temp
- (1)61 Loss of Air Flow

Fire Supervisory

- (2)AA 24 Hour non-Burg
- (2)A1 Low Water Pressure
- (2)A2 Low CO2
- (2)A3 Gate Valve Sensor
- (2)A4 Low water level
- (2)A5 Pump activated
- (2)A6 Pump failure

System Troubles

- (3)AA System Trouble
- (3)A1 AC Loss
- (3)A2 Low System Battery
- (3)A3 RAM checksum bad*
- (3)A4 ROM checksum bad*
- (3)A5 System Reset*
- (3)A6 Panel prog. changed*
- (3)A7 Self-test failure
- (3)A8 System Shutdown
- (3)A9 Battery Test Failure
- (3)1A Ground Fault

Sounder / Relay Troubles

- (3)2A Sounder / Relay
- (3)21 Bell 1
- (3)22 Bell 2
- (3)23 Alarm Relay
- (3)24 Trouble Relay
- (3)25 Reversing

System Peripheral Troubles

- (3)3A System Peripheral
- (3)31 Polling Loop Open
- (3)32 Polling Loop Short
- (3)33 Exp. Module Failure
- (3)34 Repeater Failure
- (3)35 Local Printer Paper Out
- (3)36 Local Printer Failure

Communication Troubles

- (3)5A Communication
- (3)51 Telco 1 Fault
- (3)52 Telco 2 Fault
- (3)53 Lng-Rnge Rad. xmtr. fault
- (3)54 Fail to Communicate
- (3)55 Loss of radio super.
- (3)56 Loss of central polling

Protection Loop Troubles

- (3)7A Protection Loop
- (3)71 Protection Loop open
- (3)72 Protection Loop short
- (3)73 Fire Trouble

Sensor Troubles

- (3)8A Sensor Trouble
- (3)81 Loss of super. RF
- (3)82 Loss of super. RPM
- (3)83 Sensor Tamper
- (3)84 RF xmtr. low batter

Open / Close

- (4)AA Open / Close
- (4)A1 O / C by User
- (4)A2 Group O / C
- (4)A3 Automatic O / C
- (4)A4 Late to O / C
- (4)A5 Deferred O / C
- (4)A6 Cancel
- (4)A7 Remote Arm / Disarm
- (4)A8 Quick Arm
- (4)A9 Keyswitch O / C

Remote Access

- (4)11 Callback request made*
- (4)12 Successful Download access*
- (4)13 Unsuccessful access*
- (4)14 System Shutdown
- (4)15 Dialer Shutdown

Access Control

- (4)21 Access denied
- (4)22 Access report by user

System Disables

- (5)AA-(5)1A

Sounder / Relay Disables

- (5)2A Sounder / Relay disable
- (5)21 Bell 1 disable
- (5)22 Bell 2 disable
- (5)23 Alarm relay disable
- (5)24 Trouble relay disable
- (5)25 Reversing relay disable

System Peripheral Disables

- (5)3A-54A

Communication Disables

- (5)51 Dialer disabled
- (5)52 Radio xmtr. disabled

Bypasses

- (5)7A Zone bypass
- (5)71 Fire bypass
- (5)72 24 Hour zone bypass
- (5)73 Burg bypass
- (5)74 Group bypass

Test / Misc.

- (6)A1 Manual Trigger Test*
- (6)A2 Periodic Test report*
- (6)A3 Periodic RF xmission*
- (6)A4 Fire test*
- (6)A5 Status report to follow*
- (6)A6 Listen-in to follow
- (6)A7 Walk test mode

* Restore not applicable

Appendix B

S I A F O R M A T

SIA Format

Level 2 (Hardcoded)

The SIA communication format used in this product follows the level 2 specifications of the SIA Digital Communication Standard - February 1993. This format will send the Account Code along with its data transmission. At the receiver, the transmission would look similar to this example:

N Ri01 BA 01

N = New Event

Ri01 = Partition / Area Identifier

BA = Burglary Alarm

01 = Zone 1

PC5016 Reporting Codes

SIA Identifiers & Auto-Reporting Code

Delay Zone Alarm/Restore	BA-XX / BH-XX *
Instant Zone Alarm/Restore	BA-XX / BH-XX *
Interior Zone Alarm/Restore	BA-XX / BH-XX *
Delay H.A. Zone Alarm/Restore	BA-XX / BH-XX *
Interior H.A. Zone Alarm/Restore	BA-XX / BH-XX *
24 Hr Burg Zone Alarm/Restore	BA-XX / BH-XX *
Standard Fire Zone Alarm/Restore	FA-XX / FH-XX *
Delayed Fire Zone Alarm/Restore	FA-XX / FH-XX *
24 Hr Supervisory Buzzer Zone Alarm/Restore ..	UA-XX / UH-XX *
24 Hr Supervisory Zone Alarm/Restore	UA-XX / UH-XX *
24 Hr Medical Zone Alarm/Restore	MA-XX / MH-XX *
24 Hr Panic Zone Alarm/Restore	PA-XX / PH-XX *
24 Hr Holdup Zone Alarm/Restore	HA-XX / HH-XX *
24 Hr Gas Zone Alarm/Restore	GA-XX / GH-XX *
24 Hr Heat Zone Alarm/Restore	KA-XX / KH-XX *
24 Hr Emergency Zone Alarm/Restore	QA-XX / QH-XX *
24 Hr Sprinkler Zone Alarm/Restore	SA-XX / SH-XX *
24 Hr Water Zone Alarm/Restore	WA-XX / WH-XX *
24 Hr Freeze Zone Alarm/Restore	ZA-XX / ZH-XX *
24 Hr Latching Tamper Alarm/Restore	BA-XX / BH-XX *
Duress Alarm	HA-00
Opening After Alarm	OR-00
Recent Closing	CR-00
Zone Expander Supervisory Alarm/Restore	UA-00/UH-00
Keypad Fire Alarm/Restore	FA-00 / FH-00
Keypad Auxiliary Alarm/Restore	MA-00 / MH-00
Keypad Panic Alarm/Restore	PA-00 / PH-00
2-Wire Smoke Alarm/Restore	FA-00 / FH-00

PC5016 Reporting Codes

SIA Identifiers & Auto-Reporting Code

Zone Tamper (1-32)	TA-XX *
Zone Tamper Restorals (1-32)	TR-XX *
General System Tamper/Restore	TA-00 / TR-00
Keypad Lockout	JA-00
Closing By Access Codes 1-32, 33, 34, 40-42	CL-XX ♦
Partial Closing	CG-XX ▼
Special Closing (DLS, Keys, Maint, Quick)	CL-00
Opening By Access Codes 1-32, 33, 34, 40-42	OP-XX ♦
Auto-Arm Cancellation	CE-00
Special Opening (DLS, Keys, Maint)	OP-00
Battery Trouble Alarm/Restore	YT-00/YR-00
AC Failure Trouble Alarm/Restore	AT-00/AR-00
Bell Circuit Trouble Alarm/Restore	UT-99/UJ-99
Fire Trouble Alarm/Restore	FT-00/FJ-00
Auxiliary Power Supply Trouble Alarm/Restore	YP-00/YQ-00
TLM Trouble Code (via LINKS)	LT-00
General System Trouble/Restore	YX-00/YZ-00
General System Supervisory/Restore	ET-00/ER-00
TLM Restoral	LR-00
FTC Restoral	YK-00
Event Buffer 75% Full Since Last Upload	JL-00
DLS Lead In	RB-00
DLS Lead Out (Successful)	RS-00
Periodic Test Transmission	RP-00
System Test	RX-00
LINKS1000 Test Transmission Code	TX-00
General Transmitter Low Battery/Restore	XT-00/XR-00
General Zone Trouble/Restore	UT-00/UJ-00

* Zone Number is Identified

♦ User Number is Identified

▼ Each Zone Number is Identified (using UB-XX)

Hookup Diagram

PC5016 CONTROL PANEL

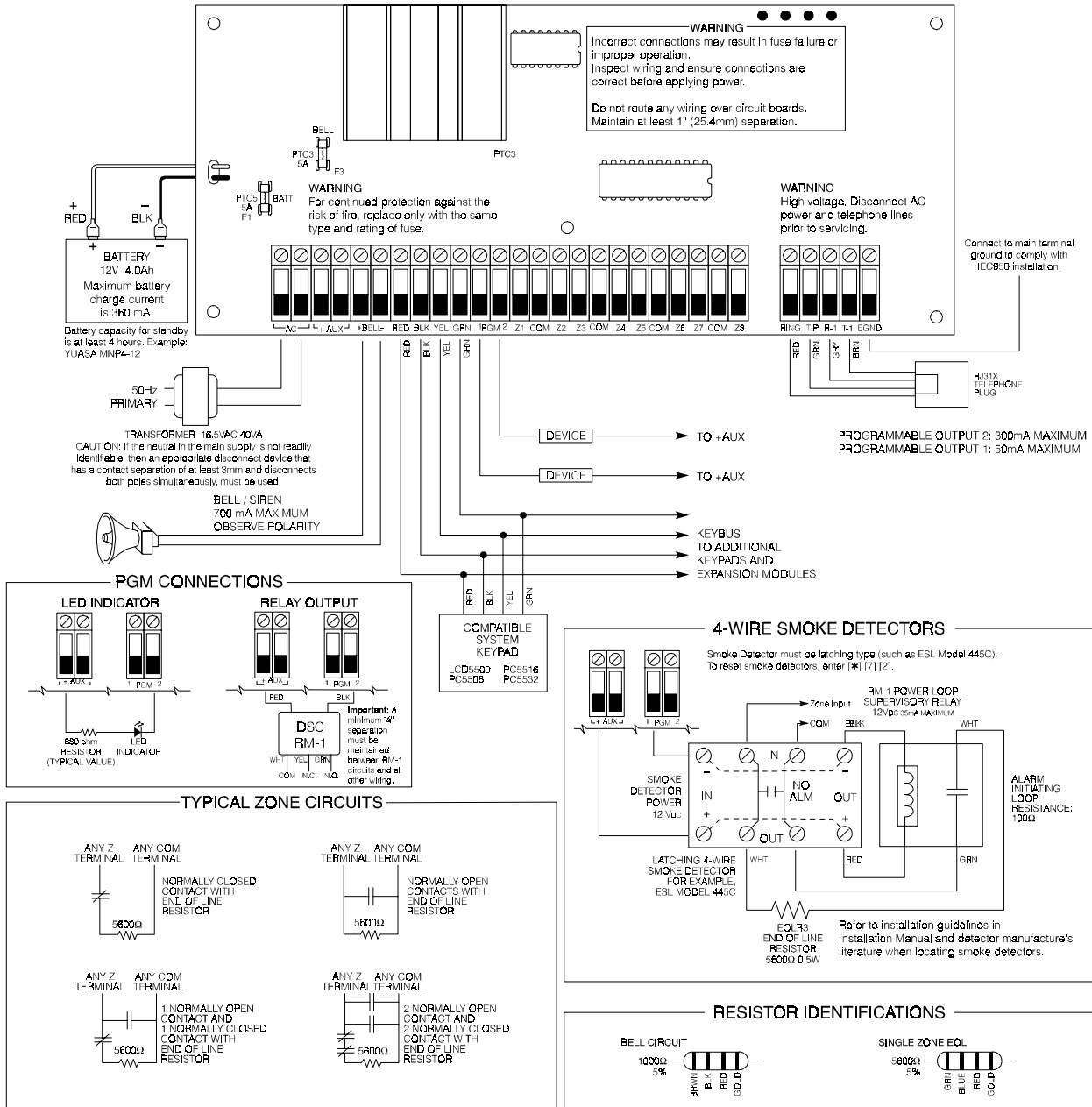

LIMITED WARRANTY

Digital Security Controls Ltd. warrants the original purchaser that for a period of twelve months from the date of purchase, the product shall be free of defects in materials and workmanship under normal use. During the warranty period, Digital Security Controls Ltd. shall, at its option, repair or replace any defective product upon return of the product to its factory, at no charge for labour and materials. Any replacement and/or repaired parts are warranted for the remainder of the original warranty or ninety (90) days, whichever is longer. The original owner must promptly notify Digital Security Controls Ltd. in writing that there is defect in material or workmanship, such written notice to be received in all events prior to expiration of the warranty period.

International Warranty

The warranty for international customers is the same as for any customer within Canada and the United States, with the exception that Digital Security Controls Ltd. shall not be responsible for any customs fees, taxes, or VAT that may be due.

Warranty Procedure

To obtain service under this warranty, please return the item(s) in question to the point of purchase. All authorized distributors and dealers have a warranty program. Anyone returning goods to Digital Security Controls Ltd. must first obtain an authorization number. Digital Security Controls Ltd. will not accept any shipment whatsoever for which prior authorization has not been obtained.

Conditions to Void Warranty

This warranty applies only to defects in parts and workmanship relating to normal use. It does not cover:

- damage incurred in shipping or handling;
- damage caused by disaster such as fire, flood, wind, earthquake or lightning;
- damage due to causes beyond the control of Digital Security Controls Ltd. such as excessive voltage, mechanical shock or water damage;
- damage caused by unauthorized attachment, alterations, modifications or foreign objects;
- damage caused by peripherals (unless such peripherals were supplied by Digital Security Controls Ltd.);
- defects caused by failure to provide a suitable installation environment for the products;
- damage caused by use of the products for purposes other than those for which it was designed;
- damage from improper maintenance;
- damage arising out of any other abuse, mishandling or improper application of the products.

Digital Security Controls Ltd.'s liability for failure to repair the product under this warranty after a reasonable number of attempts will be limited to a replacement of the product, as the exclusive remedy for breach of warranty. Under no circumstances shall Digital Security Controls Ltd. be liable for any special, incidental, or consequential damages based upon breach of warranty, breach of contract, negligence, strict liability, or any other legal theory. Such damages include, but are not limited to, loss of profits, loss of the product or any associated equipment, cost of capital, cost of substitute or replacement equipment, facilities or services, down time, purchaser's time, the claims of third parties, including customers, and injury to property.

Disclaimer of Warranties

This warranty contains the entire warranty and shall be in lieu of any and all other warranties, whether expressed or implied (including all implied warranties of merchantability or fitness for a particular purpose) And of all other obligations or liabilities on the part of Digital Security Controls Ltd. Digital Security Controls Ltd. neither assumes nor authorizes any other person purporting to act on its behalf to modify or to change this warranty, nor to assume for it any other warranty or liability concerning this product.

This disclaimer of warranties and limited warranty are governed by the laws of the province of Ontario, Canada.

WARNING: Digital Security Controls Ltd. recommends that the entire system be completely tested on a regular basis. However, despite frequent testing, and due to, but not limited to, criminal tampering or electrical disruption, it is possible for this product to fail to perform as expected.

Installer's Lockout

Any products returned to DSC which have the Installer's Lockout option enabled and exhibit no other problems will be subject to a service charge.

Out of Warranty Repairs

Digital Security Controls Ltd. will at its option repair or replace out-of-warranty products which are returned to its factory according to the following conditions. Anyone returning goods to Digital Security Controls Ltd. must first obtain an authorization number. Digital Security Controls Ltd. will not accept any shipment whatsoever for which prior authorization has not been obtained.

Products which Digital Security Controls Ltd. determines to be repairable will be repaired and returned. A set fee which Digital Security Controls Ltd. has predetermined and which may be revised from time to time, will be charged for each unit repaired.

Products which Digital Security Controls Ltd. determines not to be repairable will be replaced by the nearest equivalent product available at that time. The current market price of the replacement product will be charged for each replacement unit.

WARNING Please Read Carefully

Note to Installers

This warning contains vital information. As the only individual in contact with system users, it is your responsibility to bring each item in this warning to the attention of the users of this system.

System Failures

This system has been carefully designed to be as effective as possible. There are circumstances, however, involving fire, burglary, or other types of emergencies where it may not provide protection. Any alarm system of any type may be compromised deliberately or may fail to operate as expected for a variety of reasons. Some but not all of these reasons may be:

■ Inadequate Installation

A security system must be installed properly in order to provide adequate protection. Every installation should be evaluated by a security professional to ensure that all access points and areas are covered. Locks and latches on windows and doors must be secure and operate as intended. Windows, doors, walls, ceilings and other building materials must be of sufficient strength and construction to provide the level of protection expected. A reevaluation must be done during and after any construction activity. An evaluation by the fire and/or police department is highly recommended if this service is available.

■ Criminal Knowledge

This system contains security features which were known to be effective at the time of manufacture. It is possible for persons with criminal intent to develop techniques which reduce the effectiveness of these features. It is important that a security system be reviewed periodically to ensure that its features remain effective and that it be updated or replaced if it is found that it does not provide the protection expected.

■ Access by Intruders

Intruders may enter through an unprotected access point, circumvent a sensing device, evade detection by moving through an area of insufficient coverage, disconnect a warning device, or interfere with or prevent the proper operation of the system.

■ Power Failure

Control units, intrusion detectors, smoke detectors and many other security devices require an adequate power supply for proper operation. If a device operates from batteries, it is possible for the batteries to fail. Even if the batteries have not failed, they must be charged, in good condition and installed correctly. If a device operates only by AC power, any interruption, however brief, will render that device inoperative while it does not have power. Power interruptions of any length are often accompanied by voltage fluctuations which may damage electronic equipment such as a security system. After a power interruption has occurred, immediately conduct a complete system test to ensure that the system operates as intended.

■ Failure of Replaceable Batteries

This system's wireless transmitters have been designed to provide several years of battery life under normal conditions. The expected battery life is a function of the device environment, usage and type. Ambient conditions such as high humidity, high or low temperatures, or large temperature fluctuations may reduce the expected battery life. While each transmitting device has a low battery monitor which identifies when the batteries need to be replaced, this monitor may fail to operate as expected. Regular testing and maintenance will keep the system in good operating condition.

■ Compromise of Radio Frequency (Wireless) Devices

Signals may not reach the receiver under all circumstances which could include metal objects placed on or near the radio path or deliberate jamming or other inadvertent radio signal interference.

■ System Users

A user may not be able to operate a panic or emergency switch possibly due to permanent or temporary physical disability, inability to reach the device in time, or unfamiliarity with the correct operation. It is important that all system users be trained in the correct operation of the alarm system and that they know how to respond when the system indicates an alarm.

■ Smoke Detectors

Smoke detectors that are a part of this system may not properly alert occupants of a fire for a number of reasons, some of which follow. The smoke detectors may have been improperly installed or positioned. Smoke may not be able to reach the smoke detectors, such as when the fire is in a chimney, walls or roofs, or on the other side of closed doors. Smoke detectors may not detect smoke from fires on another level of the residence or building.

Every fire is different in the amount of smoke produced and the rate of burning. Smoke detectors cannot sense all types of fires equally well. Smoke detectors may not provide timely warning of fires caused by carelessness or safety hazards such as smoking in bed, violent explosions, escaping gas, improper storage of flammable materials, overloaded electrical circuits, children playing with matches or arson.

Even if the smoke detector operates as intended, there may be circumstances when there is insufficient warning to allow all occupants to escape in time to avoid injury or death.

■ Motion Detectors

Motion detectors can only detect motion within the designated areas as shown in their respective installation instructions. They cannot discriminate between intruders and intended occupants. Motion detectors do not provide volumetric area protection. They have multiple beams of detection and motion can only be detected in unobstructed areas covered by these beams. They cannot detect motion which occurs behind walls, ceilings, floor, closed doors, glass partitions, glass doors or windows. Any type of tampering whether intentional or unintentional such as masking, painting, or spraying of any material on the lenses, mirrors, windows or any other part of the detection system will impair its proper operation.

Passive infrared motion detectors operate by sensing changes in temperature. However their effectiveness can be reduced when the ambient temperature rises near or above body temperature or if there are intentional or unintentional sources of heat in or near the detection area. Some of these heat sources could be heaters, radiators, stoves, barbecues, fireplaces, sunlight, steam vents, lighting and so on.

■ Warning Devices

Warning devices such as sirens, bells, horns, or strobes may not warn people or waken someone sleeping if there is an intervening wall or door. If warning devices are located on a different level of the residence or premise, then it is less likely that the occupants will be alerted or awakened. Audible warning devices may be interfered with by other noise sources such as stereos, radios, televisions, air conditioners or other appliances, or passing traffic. Audible warning devices, however loud, may not be heard by a hearing-impaired person.

■ Telephone Lines

If telephone lines are used to transmit alarms, they may be out of service or busy for certain periods of time. Also an intruder may cut the telephone line or defeat its operation by more sophisticated means which may be difficult to detect.

■ Insufficient Time

There may be circumstances when the system will operate as intended, yet the occupants will not be protected from the emergency due to their inability to respond to the warnings in a timely manner. If the system is monitored, the response may not occur in time to protect the occupants or their belongings.

■ Component Failure

Although every effort has been made to make this system as reliable as possible, the system may fail to function as intended due to the failure of a component.

■ Inadequate Testing

Most problems that would prevent an alarm system from operating as intended can be found by regular testing and maintenance. The complete system should be tested weekly and immediately after a break-in, an attempted break-in, a fire, a storm, an earthquake, an accident, or any kind of construction activity inside or outside the premises. The testing should include all sensing devices, keypads, consoles, alarm indicating devices and any other operational devices that are part of the system.

■ Security and Insurance

Regardless of its capabilities, an alarm system is not a substitute for property or life insurance. An alarm system also is not a substitute for property owners, renters, or other occupants to act prudently to prevent or minimize the harmful effects of an emergency situation.



© 1997 Digital Security Controls Ltd.
1645 Flint Road, Downsview, Ontario, Canada M3J 2J6
Tel. (416) 665-8460 • Fax (416) 665-7498
Printed in Canada 29002367 R0

Installation Manual

DSC™
Power 832™

S E C U R I T Y S Y S T E M

WARNING This manual contains information on limitations regarding product use and function and information on the limitations as to liability of the manufacturer. The entire manual should be carefully read.

PC5016
Version 1.1

Table of Contents

Section 1 – System Introduction

1.1	Specifications	1
1.2	Additional Devices	2
1.2.1	Keypads	2
1.2.2	PC5108 Eight Zone Expander Module	2
1.2.3	PC5204 Power Supply Output Module	2
1.2.4	PC5208 Eight Low Current Output Module	2
1.2.5	Escort5580 Module	2
1.2.6	PC5928 Audio Interface Module	2
1.2.7	PC5400 Printer Module	3
1.2.8	Cabinets	3
1.2.9	Backplates	3
1.3	Out of the Box	3

Section 2 – Getting Started

2.1	Installation Steps	4
2.2	Terminal Descriptions	4
2.3	Keybus Operation and Wiring	6
2.4	Current Ratings - Modules and Accessories	6
2.5	Assigning Zones to Zone Expanders	7
2.6	Keypad Assignment	7
2.6.1	How to Assign Keypads	8
2.6.2	How to Program Function Keys	8
2.7	Enable Supervision	8
2.8	Removing Modules	8
2.9	Zone Wiring	9
2.9.1	Normally Closed (NC) Loops	9
2.9.2	Single End of Line (EOL) Resistors	9
2.9.3	Double End of Line (DEOL) Resistors	9
2.9.4	Fire Zone Wiring - 4 wire Smoke Detectors	10
2.9.5	Keyswitch Zone Wiring	10

Section 3 – Keypad Commands

3.1	Access Codes	11
3.2	Arming/Disarming	11
3.3	Auto Bypass	12
3.4	[*] Commands	12
[*]+[1]	Zone Bypass/Reactivate Stay/Away Zones	12
[*]+[2]	Trouble Display	13
[*]+[3]	Alarm Memory	14
[*]+[4]	Doorchime On/Off	14
[*]+[5]	Programming Access Codes	14
[*]+[6]	User Functions	15
[*]+[7]	Output Functions	16
[*]+[8]	Installer Programming	16
[*]+[9]	Arming Without Entry Delay	16
[*]+[0]	Quick Arm/Quick Exit	16
3.5	Function Keys	17
3.5.1	Function Key Options	17
3.6	Global and Partition Keypad Operation	18

Section 4 – How to Program

4.1	How to Enter Installer Programming	19
4.2	Programming Decimal Data	19
4.3	Programming HEX Data	19
4.4	Programming Toggle Option Sections	20
4.5	Viewing Programming	20
4.5.1	LED Keypads	20
4.5.2	LCD Keypads	20

Section 5 – Programming Descriptions

5.1	Zone Definitions	21
5.2	Zone Attributes	22
5.3	Communicator - Dialing	23
5.4	Communicator - Phone Numbers	23
5.5	Communicator - Account Numbers	24
5.6	Communicator - Reporting Formats	24
5.6.1	Pulse Formats	24
5.6.2	Contact ID	24
5.6.3	SIA (Level 2)	25
5.6.4	Pager Format	25
5.6.5	200 Baud FSK	25
5.7	Communicator - Reporting Codes	26
5.7.1	Zone Alarm	26
5.7.2	Zone Restoral	26
5.7.3	Closings	26
5.7.4	Openings	26
5.7.5	Tampers	26
5.7.6	Priority/Emergency	27
5.7.7	Maintenance	27
5.7.8	Test Transmissions	27
5.7.9	Miscellaneous	27
5.8	Downloading	28
5.9	Partitions/Zone Assignment	28
5.10	PGM Outputs	29
5.10.1	PGM Output Options	29
5.10.2	PGM Output Attributes	30
5.11	Telephone Line Monitor (TLM)	30
5.12	Siren Supervision	31
5.13	Test Transmission	31
5.14	Fire, Auxiliary, Panic Keys	31
5.15	Entry/Exit Delay Options	32
5.16	Event Buffer	32
5.16.1	Viewing the Event Buffer through the LCD Keypad	32
5.17	Swinger Shutdown	33
5.18	Transmission Delay	33
5.19	Keypad Backlighting	33
5.20	Arming/Disarming Options	33
5.21	Automatic Arming	33
5.22	Keypad Lockout	34
5.23	Keypad Blanking	34
5.24	Loop Response	34
5.25	Keypad Tampers	34
5.26	Escort5580 Module	35
5.27	On-Site Printer	35
5.28	Audio Interface Module	35
5.29	Default (Factory)	35
5.29.1	Factory Default Main Panel (Hardware)	35
5.29.2	Factory Default Main Panel (Software) and other Modules	36
5.30	Installer Lockout	36
5.31	Walk Test (Installer)	36
5.32	International Programming	36
5.32.1	[700] Automatic Clock Adjust	36
5.32.2	[701] First International Option Code	36
5.32.3	[702] Second International Option Code	37
5.32.4	[703] Delay Between Dialing Attempts	37

Appendix A – Contact ID	38
--------------------------------	-----------

Appendix B – SIA Format	39
--------------------------------	-----------

PC5016 Control Panel Hookup Diagram	40
--	-----------