

JS-11 Harmony P.I.R. detector

Description

- Passive Infrared Motion Detector
- Advanced digital signal processing
- SMD circuitry, excellent RFI immunity (CE)
- White light immunity, insect proof housing
- Automatic temperature compensation, self testing software
- Alarm memory function, TAMPER protection
- Fast, easy installation, high reliability

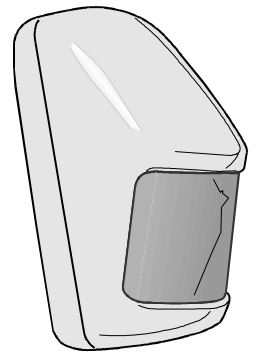

Specifications:

power consumption	9-15V DC	ALARM relay	60V / 0,1A (N.O., N.C.)
stand-by	5mA (relay OFF)	TAMPER switch	60V / 0,1A
	20mA (relay ON)	warm up time	max. 90 sec.
data processing	digital analysis (3 optional rates)	operating temperature	-10 to +55°C
detection speed	min. 0,1 m/sec - max. 4 m/sec	RF immunity	to 1 GHz 20V/m (modulated sig.)
detection coverage	12m / 120°		

Complies with: EN55022, 60801-2 (IEC801-2), IEC801-3, IEC801-4.

Installation:

The detector should be installed on a flat wall 2 to 2,5m above the floor. Use the two provided screws to attach the housing to the surface. If you install the detector into a corner, use the plastic holder (see following diagrams). The coverage zone can be adjusted by changing the position of the PCB module inside the detector. The diagram below shows the three zones (A,B & C) of coverage.

The detector installation into corner using the holder

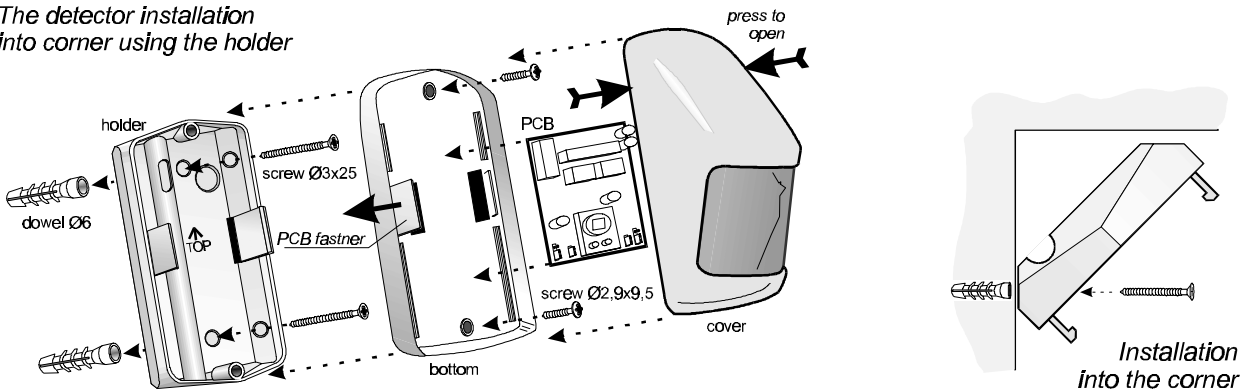

The detector coverage

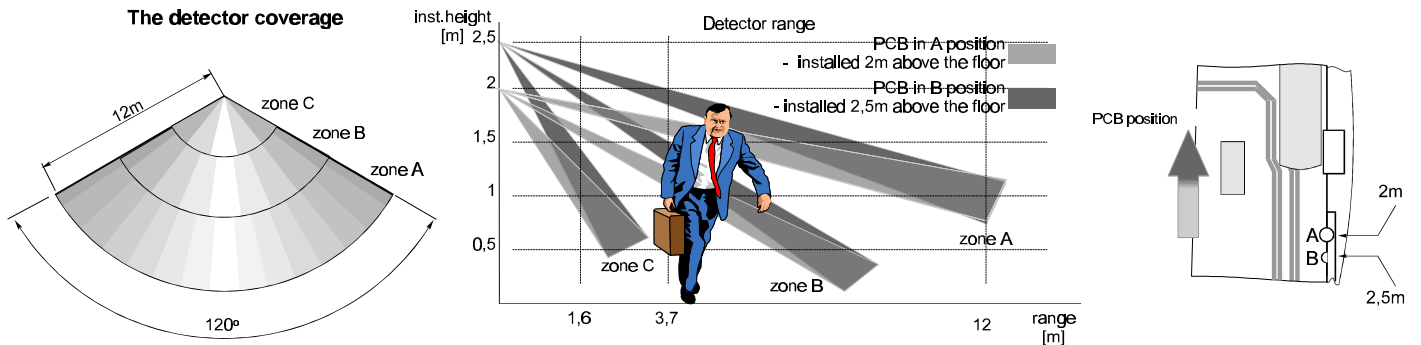



Content of the set :

- JS-10 detector
- holder
- dowel Ø6mm (2x)
- screw Ø 3x25mm (2x)
- screw Ø 2,9x9,5mm (2x)

Terminals:

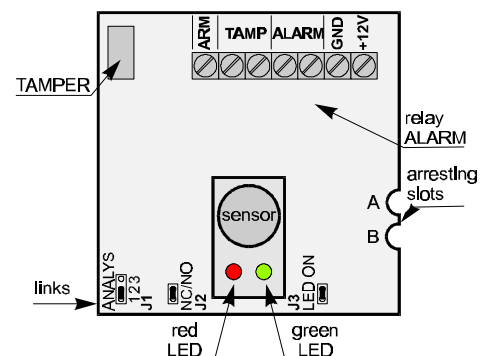
- ARM** - alarm memory input (GND when system armed - optional)
- TAMP** - TAMPER switch output N.C.
- +12V** - power supply +12VDC
- GND** - ground
- ALARM** - alarm relay output (N.C. or N.O.)

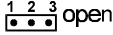

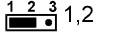
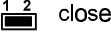
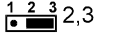
Selectable links:		Jumper positions	
J1 - ANALYSIS - rate of the digital signal analysis		 open	 open
1,2 fast reaction, good immunity (normal environment)		 1,2	 close
2,3 high immunity, slower speed (high RF noise)		 2,3	
open excellent immunity, slow reaction (very high RF noise, frequent temperature changes)			
J2 - NC/NO - alarm relay output function		J3 - LED ON - LED function	
closed relay has Normally Closed contact		closed normal walk test function	
open relay has Normally Open contact		open green LED is OFF, red LED function is reduced (only alarm memory and trouble signals)	

LED functions:

- green** - indicates if any movement is detected (signal analysis started). If J3 jumper is open this LED will be completely OFF.
- red**
 - periodically flashes (twice a second) indicates the warming-up time after power connection
 - three seconds signal indicates ALARM relay output triggering. If jumper J3 is open, the triggering will not be indicated
 - fast short flashes indicate an alarm memory (will be reset after next control panel arming)
 - permanent light with two fast pauses indicates that a P.I.R. function trouble was detected. These signals are provided even if the J3 link is open.

Note: after power supply connecting, the detector needs about 90 seconds for warming up and the automatic self-testing procedure. The red LED will flash periodically during this period.

Function description:

Digital signal analysis: the built-in sensor detects any movement of objects which a temperature being close to the human body temperature. The signal from the sensor is converted to digital form and analyzed by software. This software checks if the signal has a form which is characteristic to human body movement. This way, false alarms are almost eliminated and attempts to block the detector's function can also be recognized. Results of the digital analysis depend on the analysis rate. This rate can be adjusted by jumper J1.

Alarm triggering: when a valid signal is analyzed, the ALARM relay is activated for 3 seconds (N.C. or N.O. function can be selected with J2 link). ALARM relay triggering is indicated by the red LED (if J3 link is closed).

ARM Input: is a control input for the alarm memory function. If the ARM terminal is activated (connected to the GND), the alarm system is armed. If the memory function is not used, do not connect this terminal. Voltage on this input can be from 0 V to +12VDC.

Alarm memory: If the ALARM is triggered when the ARM input is on GND (control panel armed), the detector's red LED will continue flashing rapidly after the control panel is disarmed. This acts as an alarm memory signal. This signal is reset by the next control panel arming.

Notes: Your control panel must first be turned to the SERVICE position whenever you are going to open the detector housing.

Warning: Do not touch the sensor inside. If you must touch it, be sure to avoid using your fingers!

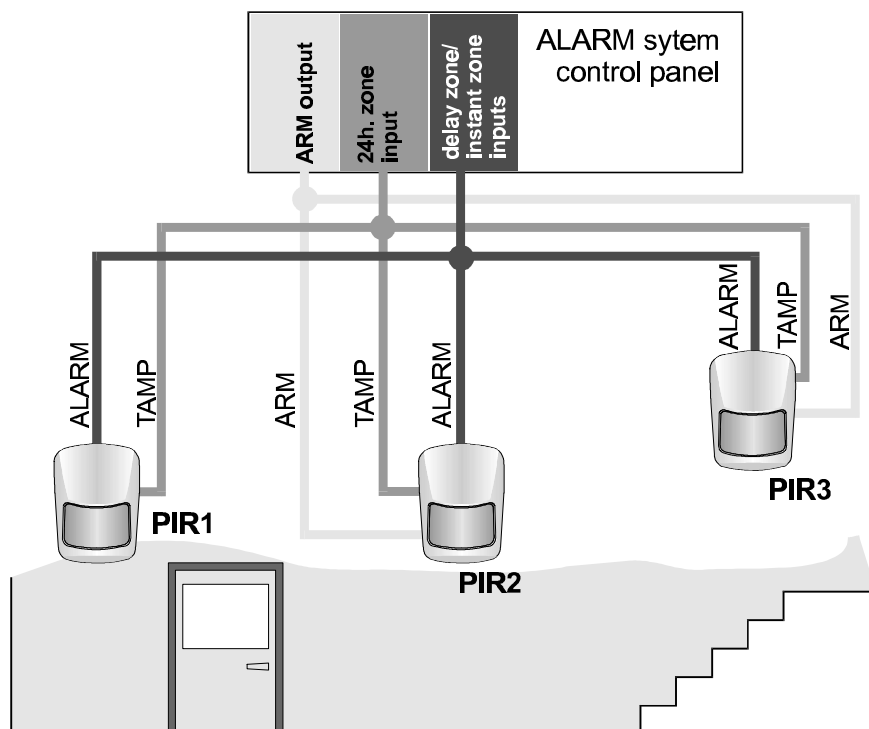

made by:

JABLOTRON Ltd.
Czech Republic
E-mail: export@jablotron.cz
http: www.jablotron.cz